



WOOD STRUCTURE IN APPROVED
PAINT FINISH WITH METAL
SUPPORT

BUILT-UP LETTER CUT OUT

2"X2" METAL GRID IN
APPROVED PAINT FINISH

LIGHT GRAY NEEDLE PUNCH CARPET

 EXHIBITION DESIGN DIVISION	PROJECT: AMBIENTE 2023	SHEET CONTENTS: WORKING DRAWING	
	TITLE: DESIGN PHILIPPINES - WORKING DRAWING	SHEET NO.: 1	REVISION: 1
DATE / TIME: DECEMBER 27, 2022	LOCATION: FRANKFURT, GERMANY		

LETTER CUT OUT

2"X2" METAL GRID IN APPROVED PAINT FINISH

STICKER CUT-OUT

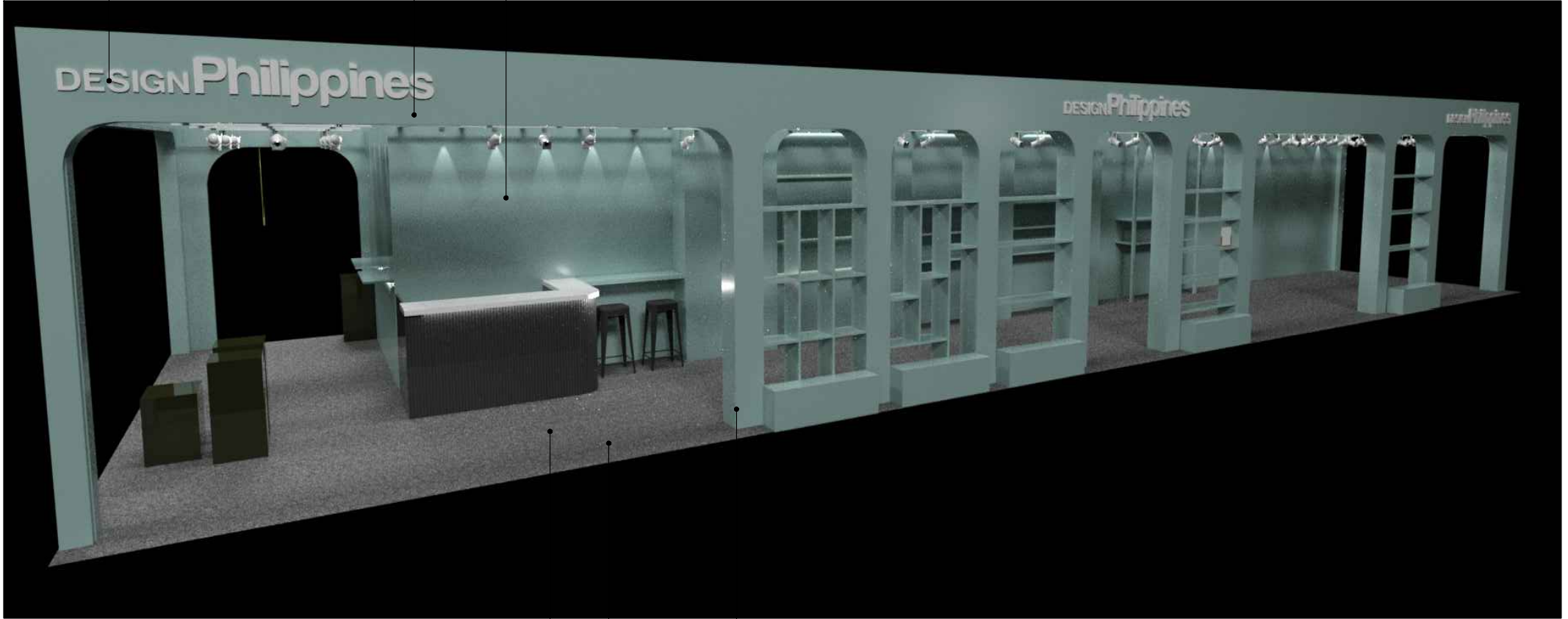



WOOD STRUCTURE IN APPROVED PAINT FINISH WITH METAL SUPPORT

LIGHT GRAY NEEDLE PUNCH CARPET

RECEPTION COUNTER

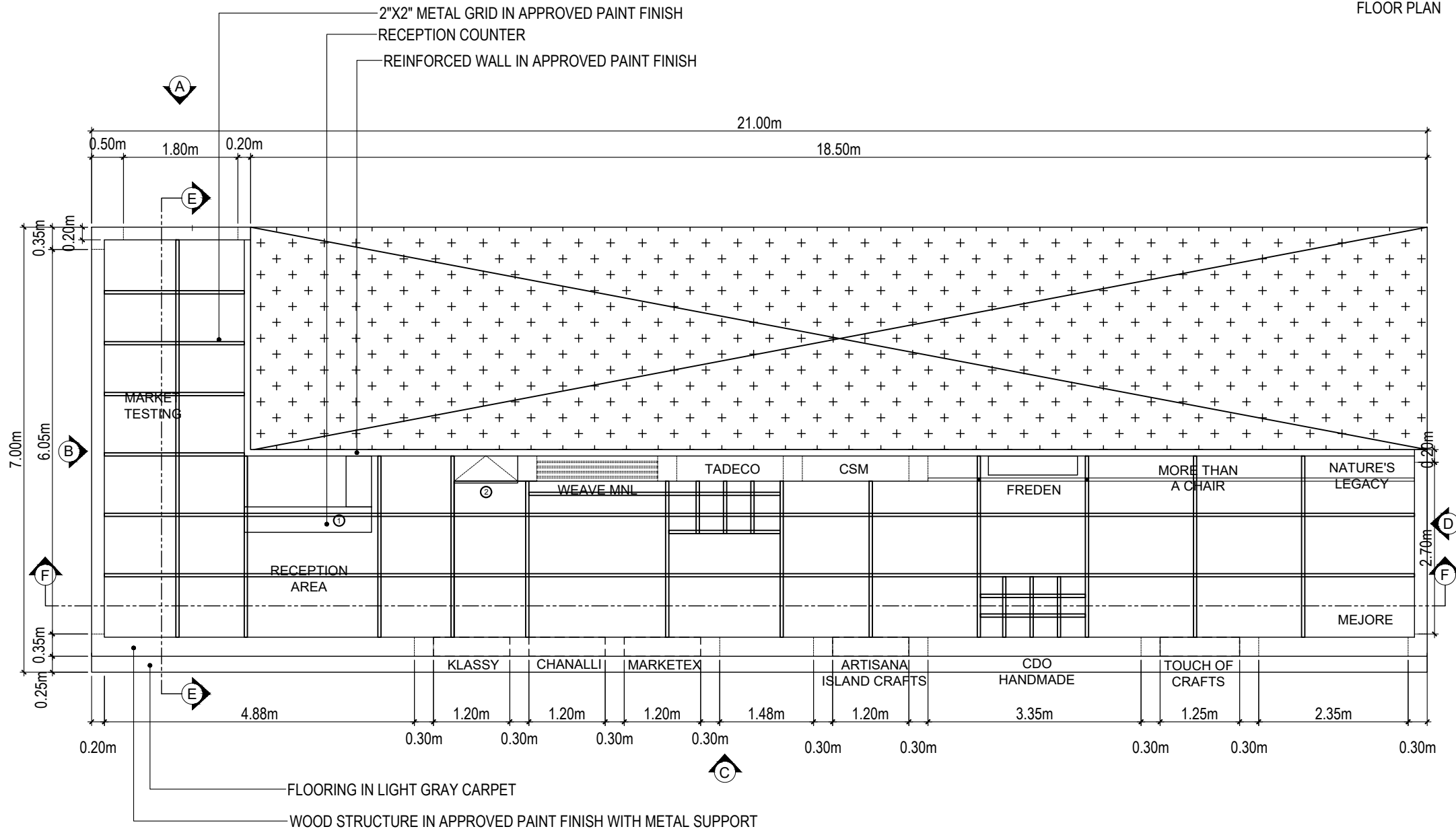
 EXHIBITION DESIGN DIVISION	PROJECT: AMBIENTE 2023	SHEET CONTENTS: WORKING DRAWING	
	TITLE: DESIGN PHILIPPINES - WORKING DRAWING	DATE / TIME: DECEMBER 27, 2022	LOCATION: FRANKFURT, GERMANY



 <p>EXHIBITION DESIGN DIVISION</p>	<p>PROJECT: AMBIENTE 2023</p>	<p>SHEET CONTENTS:</p>	
	<p>TITLE: DESIGN PHILIPPINES - WORKING DRAWING</p>	<p>WORKING DRAWING</p>	
<p>DATE / TIME: DECEMBER 27, 2022</p>	<p>LOCATION: FRANKFURT, GERMANY</p>	<p>SHEET NO.: 3</p>	<p>REVISION: 1</p>

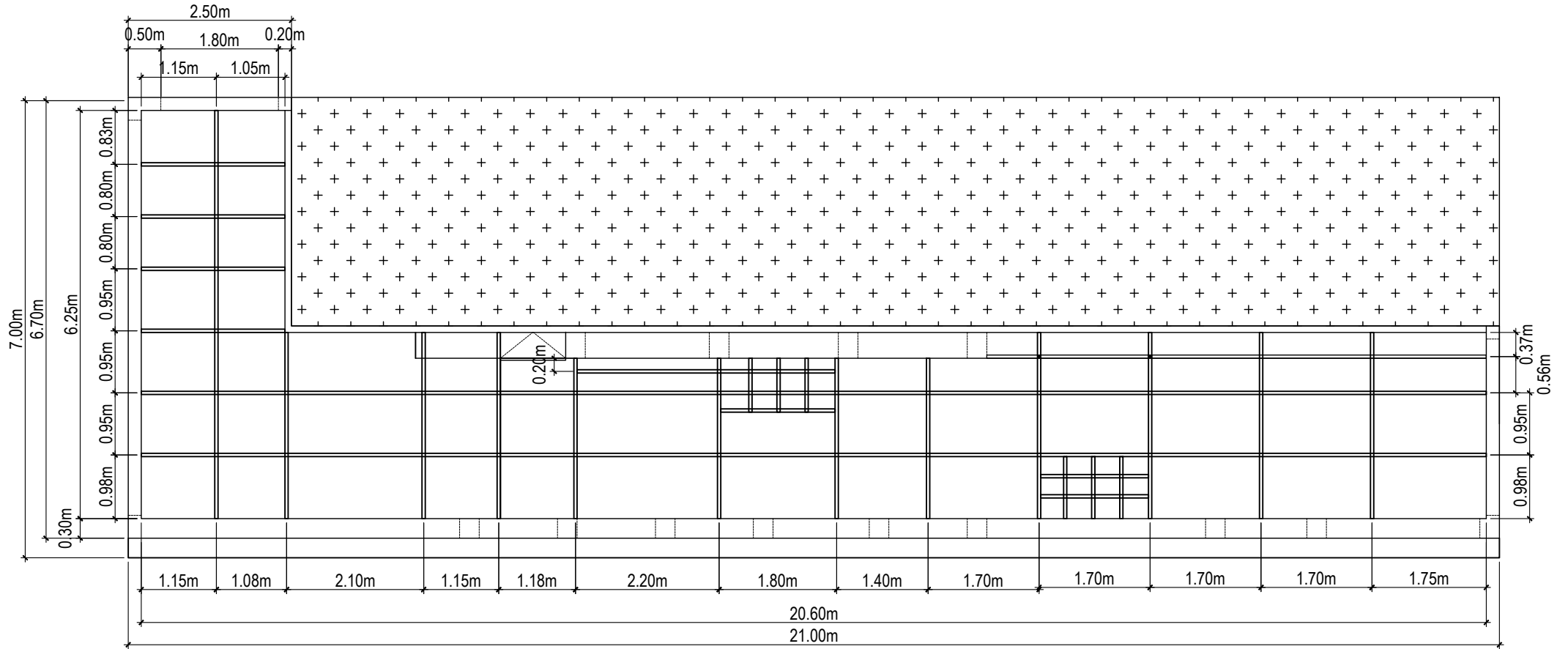

PROJECT:	AMBIENTE 2023	SHEET CONTENTS:	
	DESIGN PHILIPPINES - WORKING DRAWING	WORKING DRAWING	
DATE / TIME:	LOCATION:	SHEET NO.:	REVISION:
DECEMBER 27, 2022	FRANKFURT, GERMANY	4	1

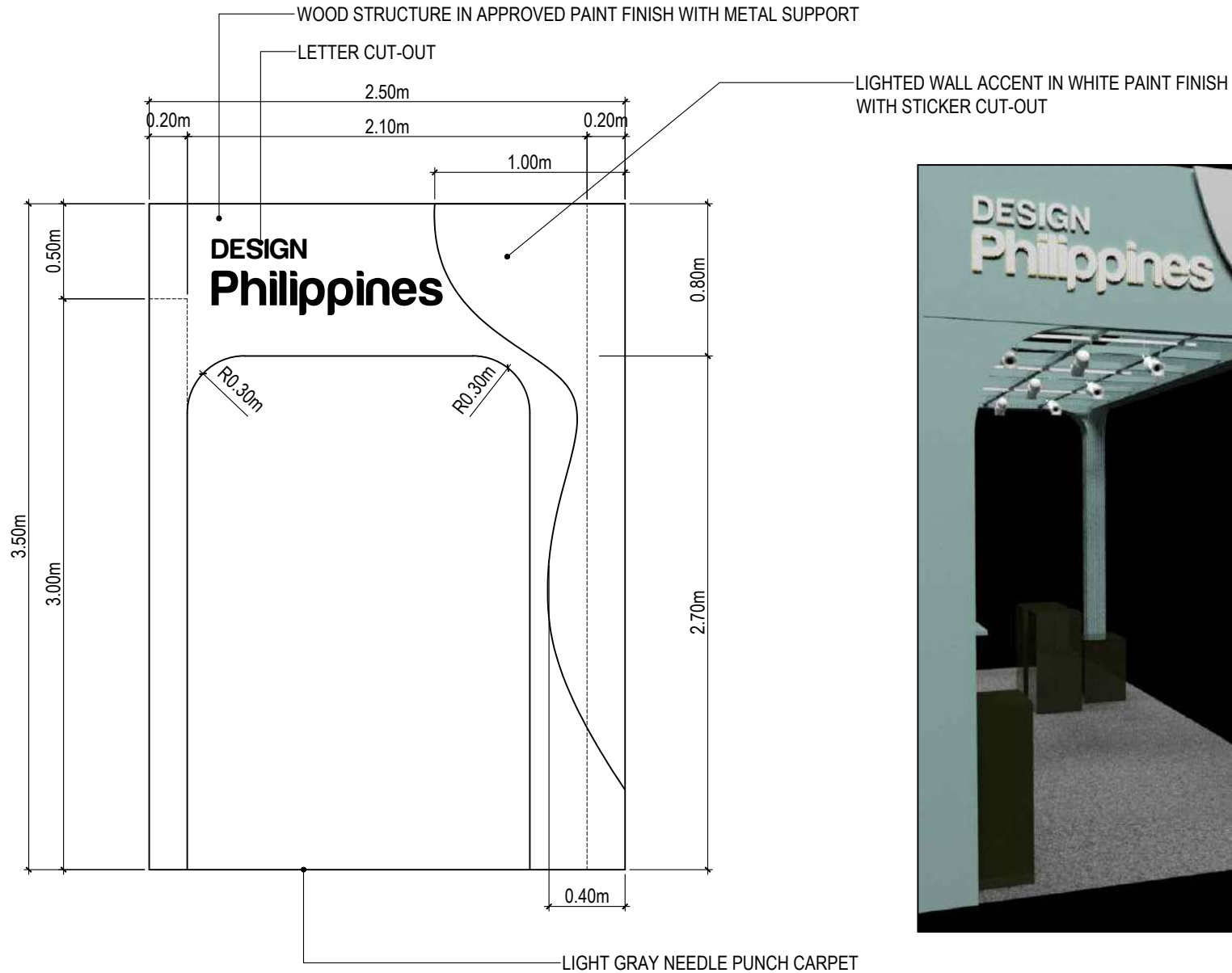

ELEVATION A

 EXHIBITION DESIGN DIVISION	PROJECT: AMBIENTE 2023	SHEET CONTENTS:	
	TITLE: DESIGN PHILIPPINES - WORKING DRAWING	WORKING DRAWING	
DATE / TIME: DECEMBER 27, 2022	LOCATION: FRANKFURT, GERMANY	SHEET NO.: 5	REVISION: 1

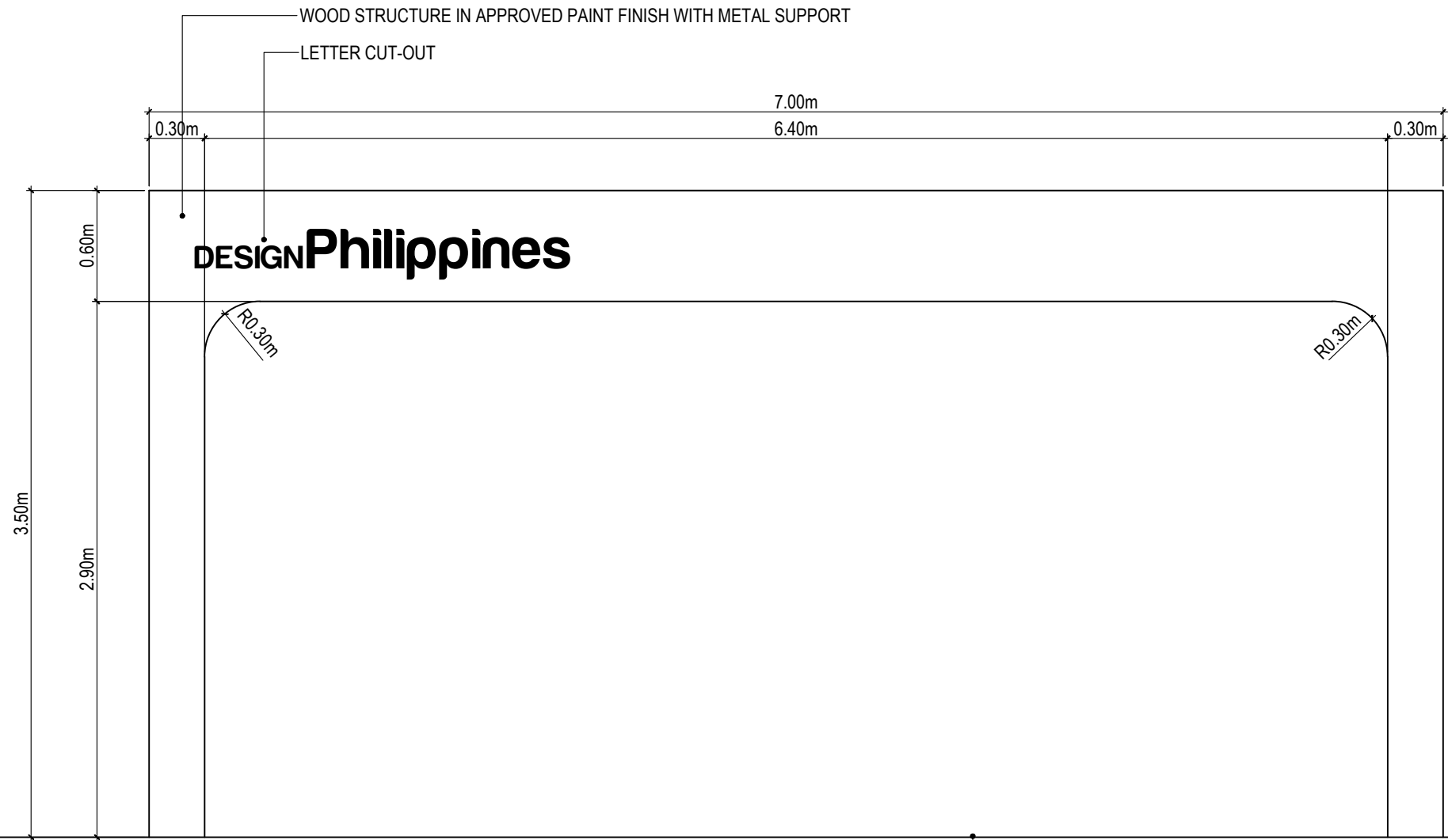

ELEVATION B

CARPET IN APPROVED FINISH



EXHIBITION DESIGN DIVISION	PROJECT:	AMBIENTE 2023	SHEET CONTENTS:	
	TITLE:	DESIGN PHILIPPINES - WORKING DRAWING	WORKING DRAWING	
DATE / TIME: DECEMBER 27, 2022	LOCATION:	FRANKFURT, GERMANY	SHEET NO.:	REVISION:
			6	1

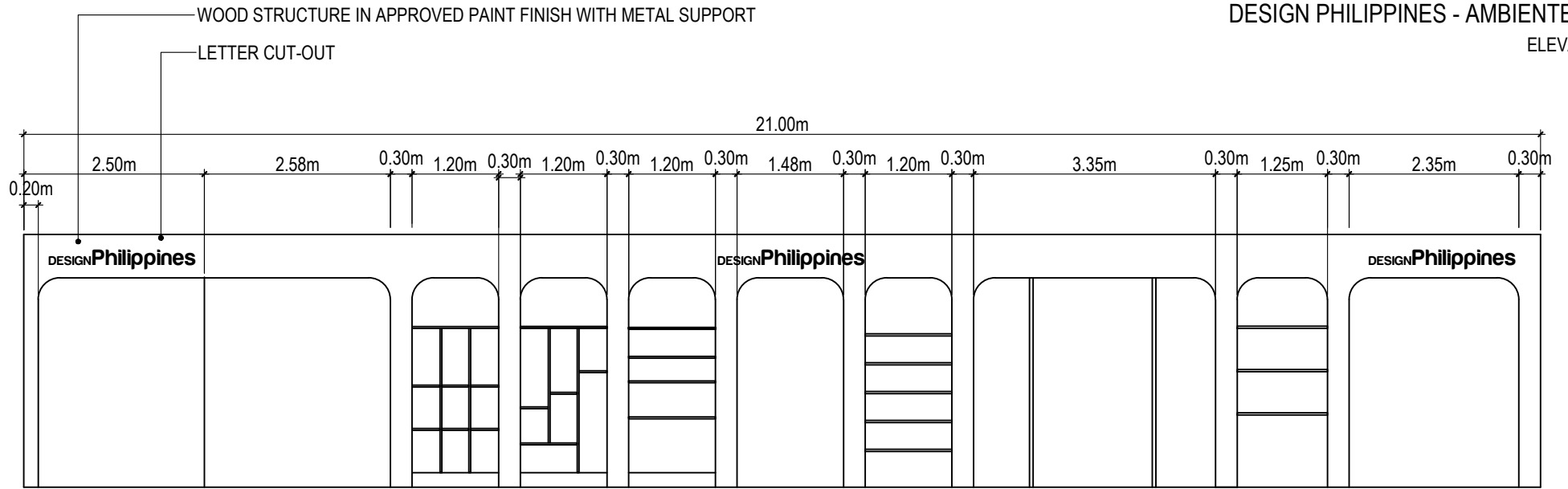

ELEVATION C

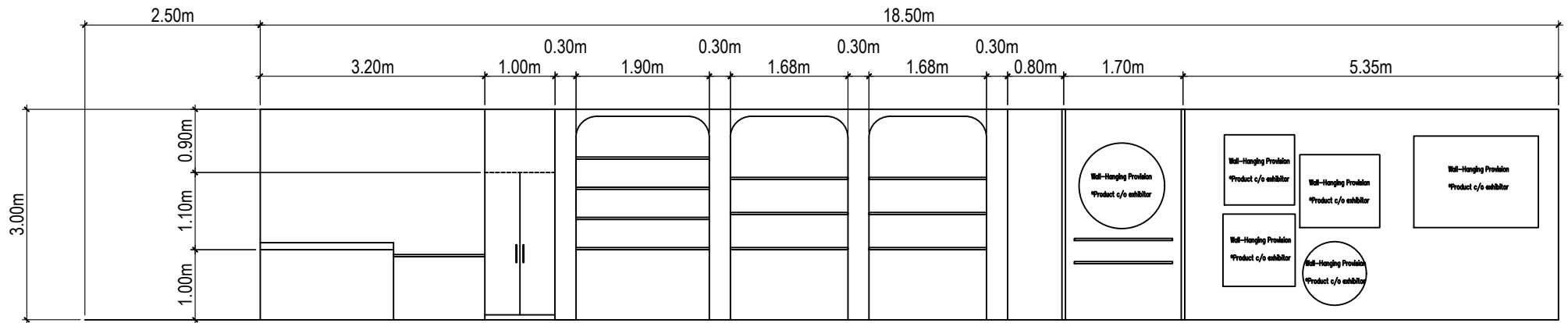

ELEVATION F

	PROJECT: AMBIENTE 2023	SHEET CONTENTS:	
	TITLE: DESIGN PHILIPPINES - WORKING DRAWING	WORKING DRAWING	
DATE / TIME: DECEMBER 27, 2022	LOCATION: FRANKFURT, GERMANY	SHEET NO.: 7	REVISION: 1

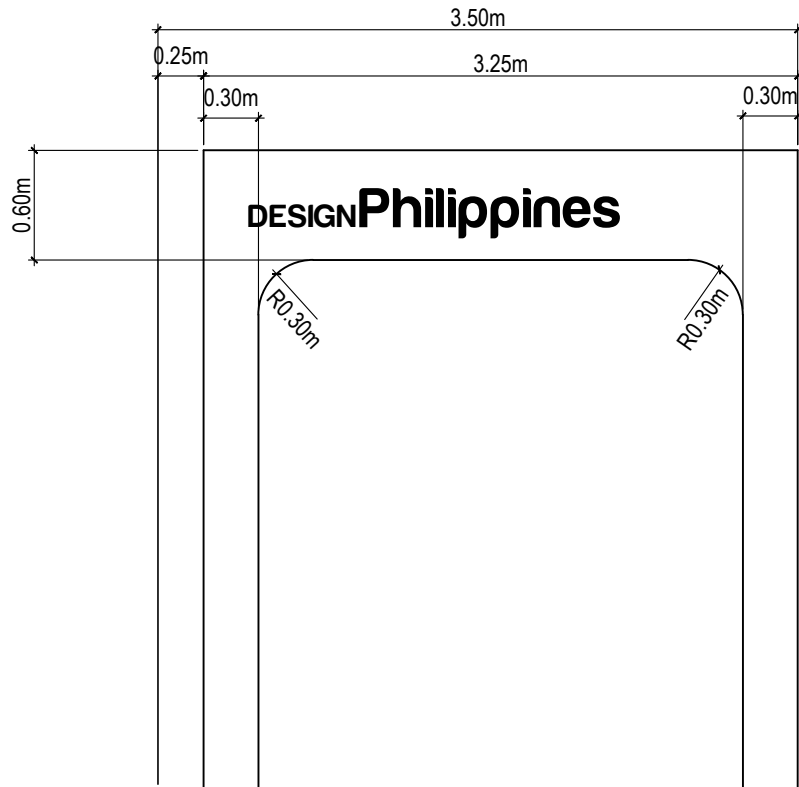

ELEVATION D

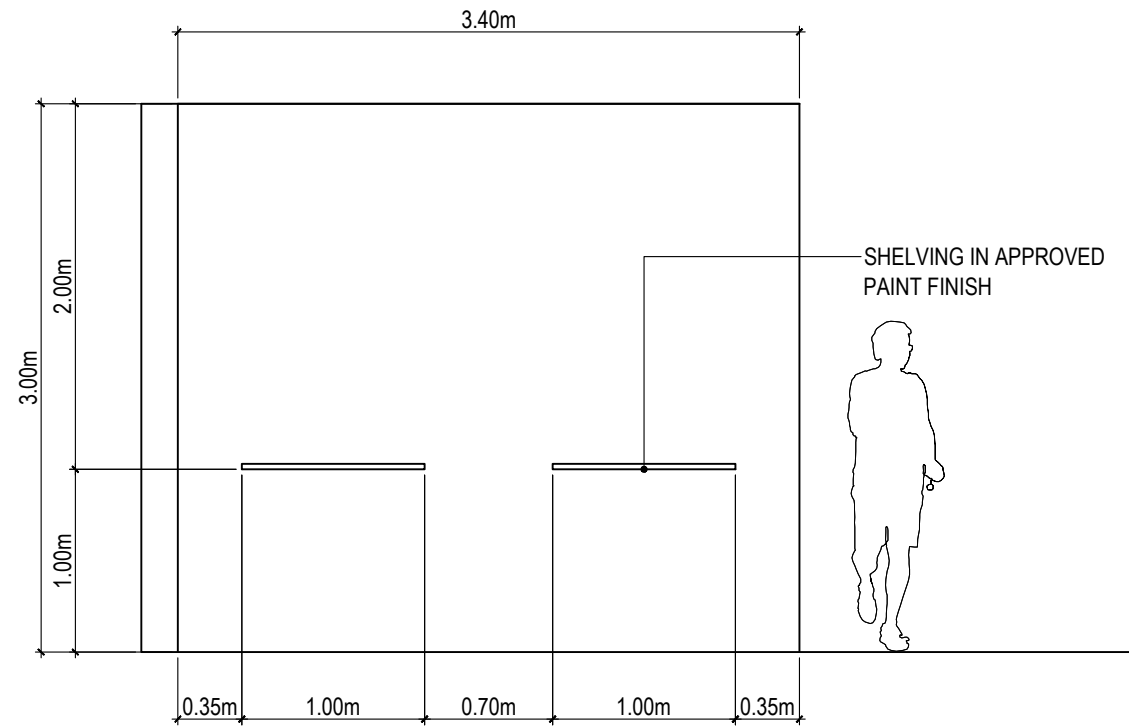

ELEVATION E



EXHIBITION DESIGN DIVISION	PROJECT:	AMBIENTE 2023	SHEET CONTENTS:	
	TITLE:	DESIGN PHILIPPINES - WORKING DRAWING	WORKING DRAWING	
DATE / TIME: DECEMBER 27, 2022	LOCATION:	FRANKFURT, GERMANY	SHEET NO.: 8	REVISION: 1

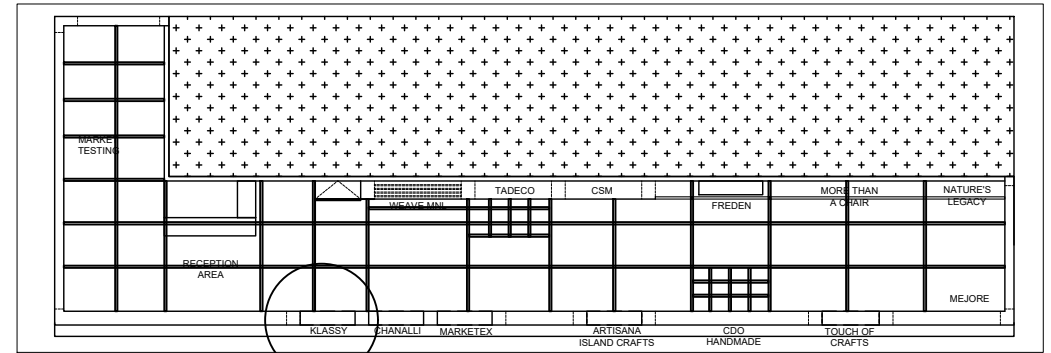
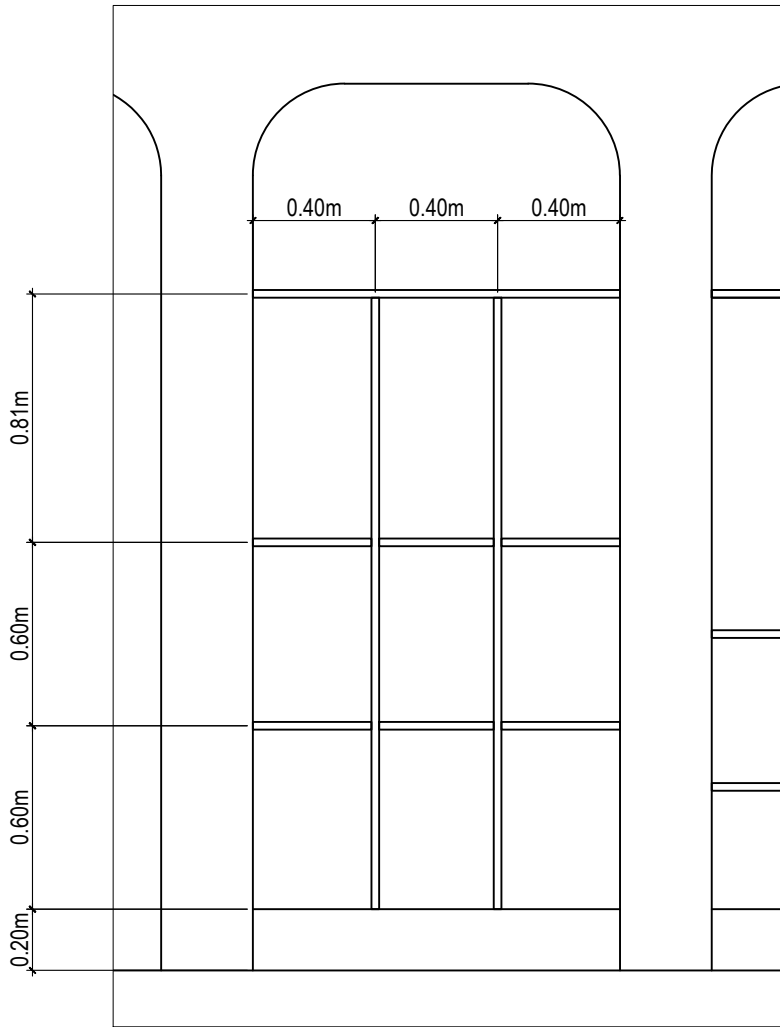
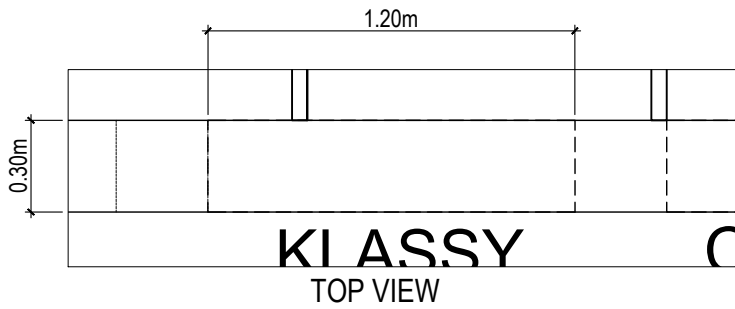

LOCATION MAP



WOOD STRUCTURE IN APPROVED
PAINT FINISH WITH METAL SUPPORT

SHELVINGS ACCORDING TO PRODUCT HEIGHT

PERSPECTIVE

<p>EXHIBITION DESIGN DIVISION</p>	PROJECT: AMBIENTE 2023	SHEET CONTENTS:	
	TITLE: DESIGN PHILIPPINES - WORKING DRAWING	WORKING DRAWING	
DATE / TIME: DECEMBER 27, 2022	LOCATION: FRANKFURT, GERMANY	SHEET NO.: 9	REVISION: 1

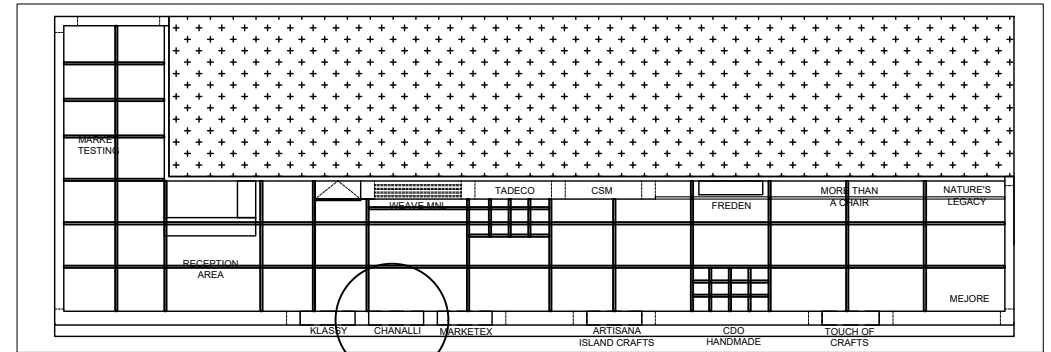
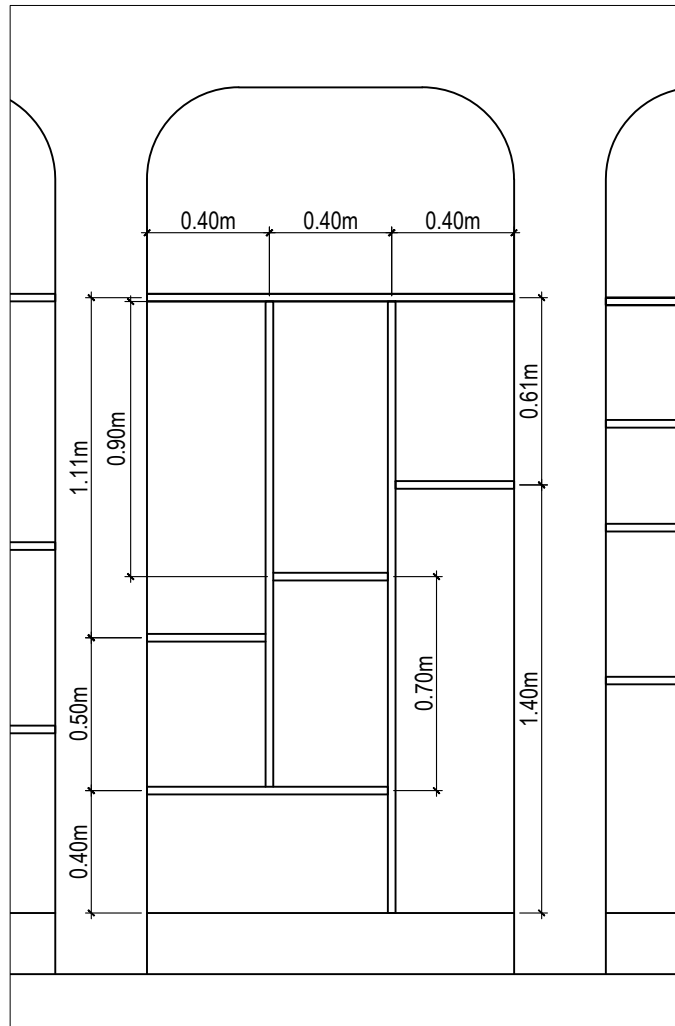
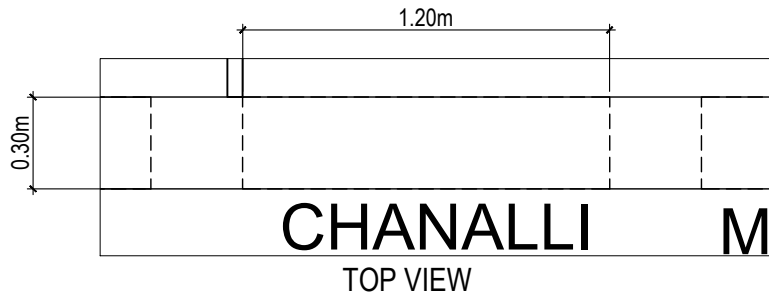

LOCATION MAP

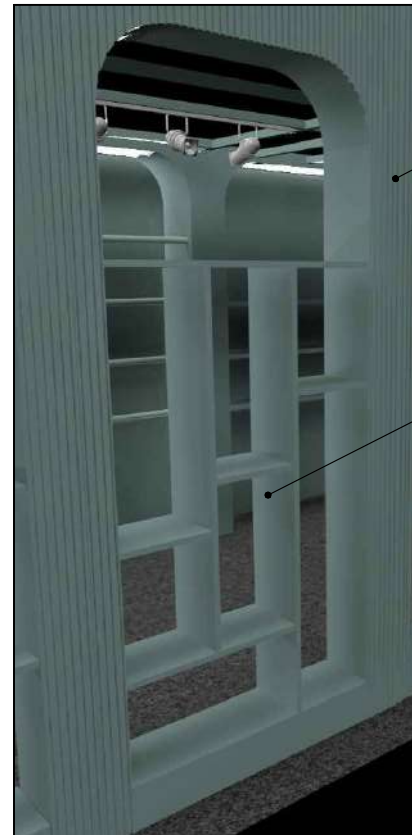

PERSPECTIVE

WOOD STRUCTURE IN APPROVED
PAINT FINISH WITH METAL SUPPORT

SHELVINGS ACCORDING TO PRODUCT HEIGHT

<p>EXHIBITION DESIGN DIVISION</p>	PROJECT: AMBIENTE 2023	SHEET CONTENTS:	
	TITLE: DESIGN PHILIPPINES - WORKING DRAWING	WORKING DRAWING	
DATE / TIME: DECEMBER 27, 2022	LOCATION: FRANKFURT, GERMANY	SHEET NO.: 10	REVISION: 1

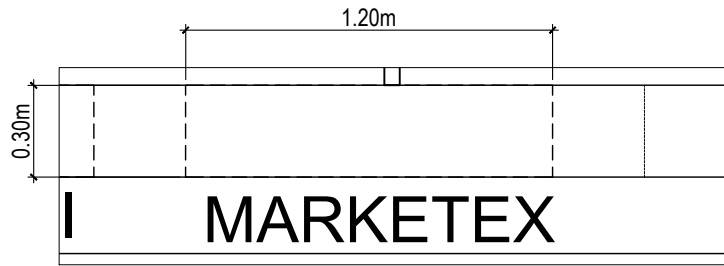

TOP VIEW

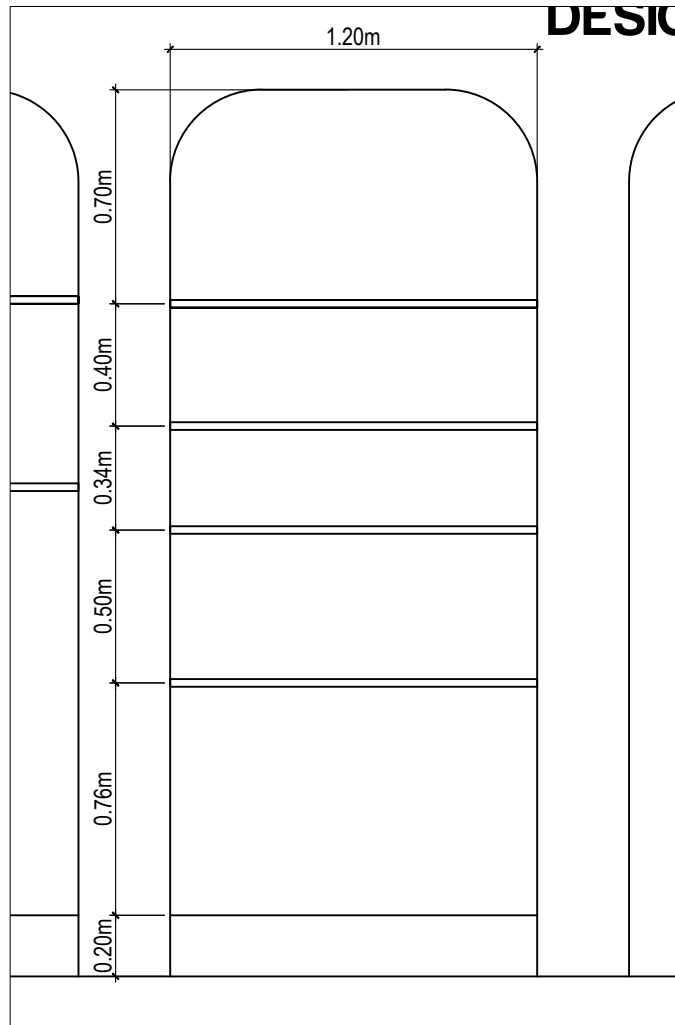

ELEVATION

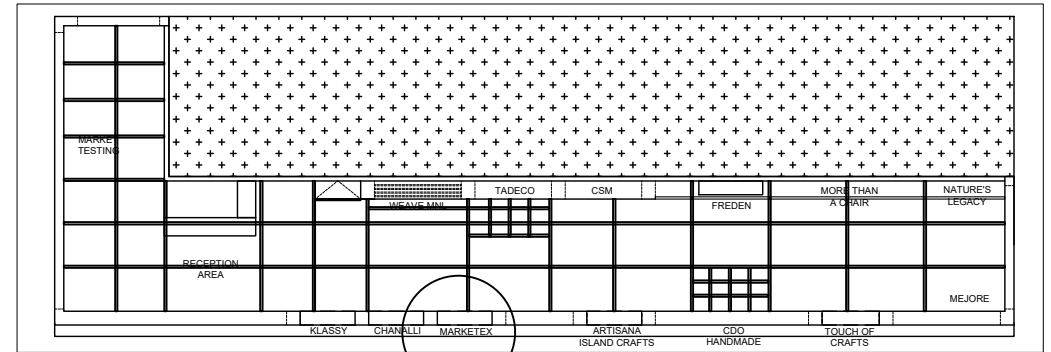

LOCATION MAP

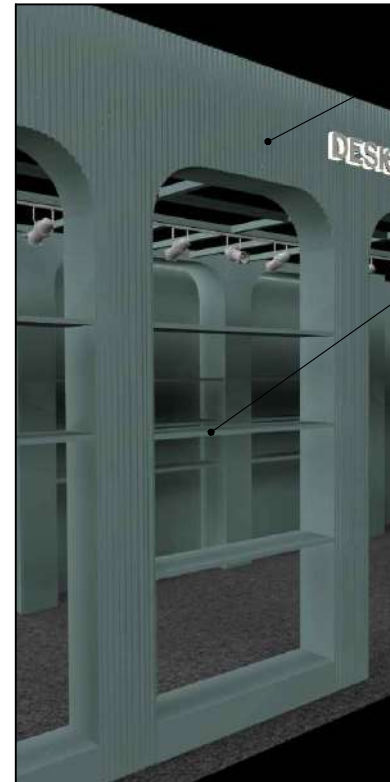

STRUCTURE WITH WOOD SLAT COVERING
IN APPROVED PAINT FINISH

SHELVINGS ACCORDING TO PRODUCT HEIGHT

PERSPECTIVE

<p>EXHIBITION DESIGN DIVISION</p>	<p>PROJECT: AMBIENTE 2023</p>	<p>SHEET CONTENTS: WORKING DRAWING</p>	
	<p>TITLE: DESIGN PHILIPPINES - WORKING DRAWING</p>		
<p>DATE / TIME: DECEMBER 27, 2022</p>	<p>LOCATION: FRANKFURT, GERMANY</p>	<p>SHEET NO.: 11</p>	<p>REVISION: 1</p>

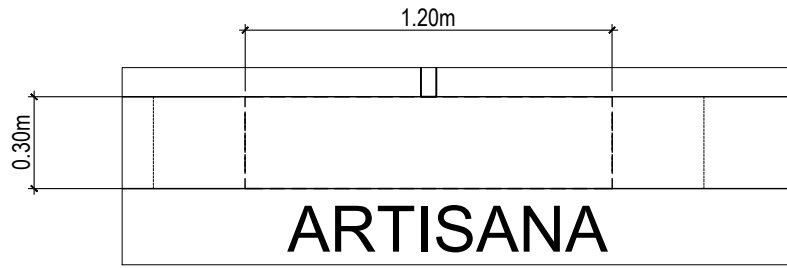

TOP VIEW

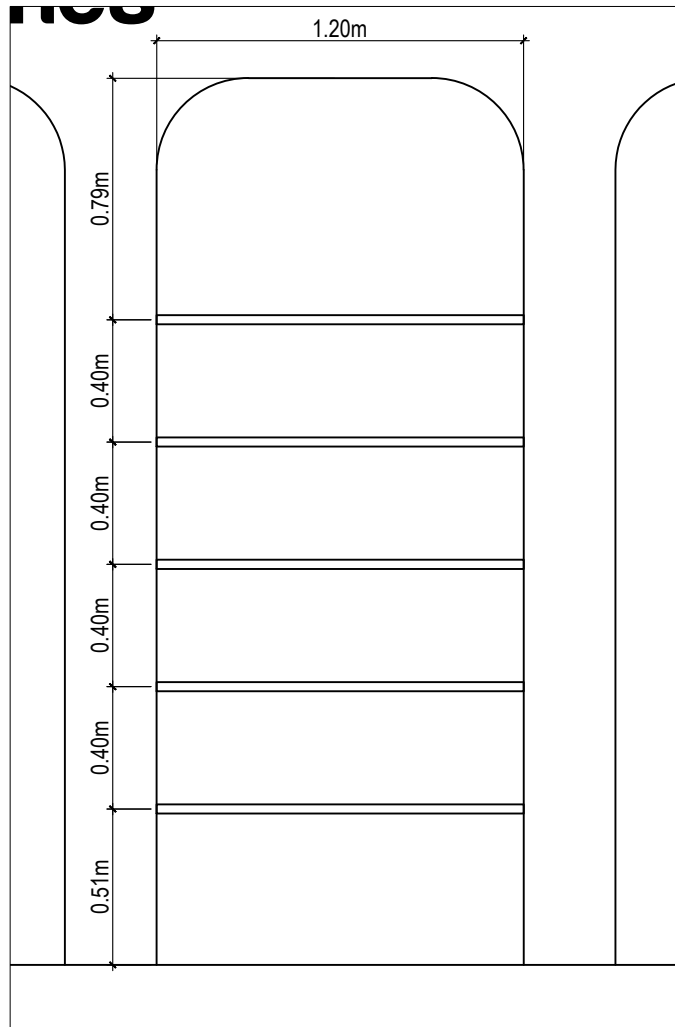

ELEVATION

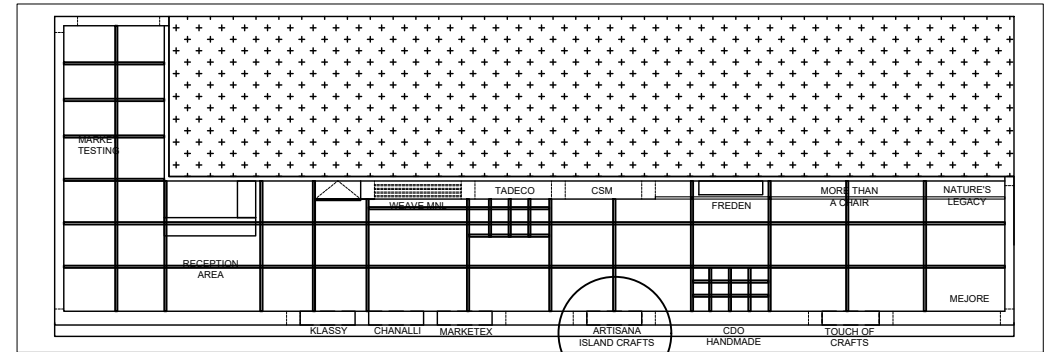

LOCATION MAP



STRUCTURE WITH WOOD SLAT COVERING
IN APPROVED PAINT FINISH

SHELVINGS ACCORDING TO PRODUCT HEIGHT

PERSPECTIVE

<p>EXHIBITION DESIGN DIVISION</p>	PROJECT:	AMBIENTE 2023	SHEET CONTENTS:	
	TITLE:	DESIGN PHILIPPINES - WORKING DRAWING	WORKING DRAWING	
DATE / TIME:	LOCATION:	FRANKFURT, GERMANY	SHEET NO.:	REVISION:
DECEMBER 27, 2022			12	1

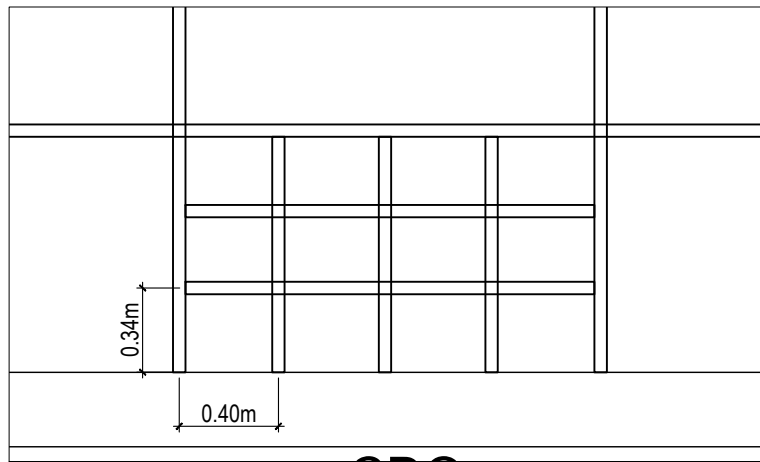

TOP VIEW

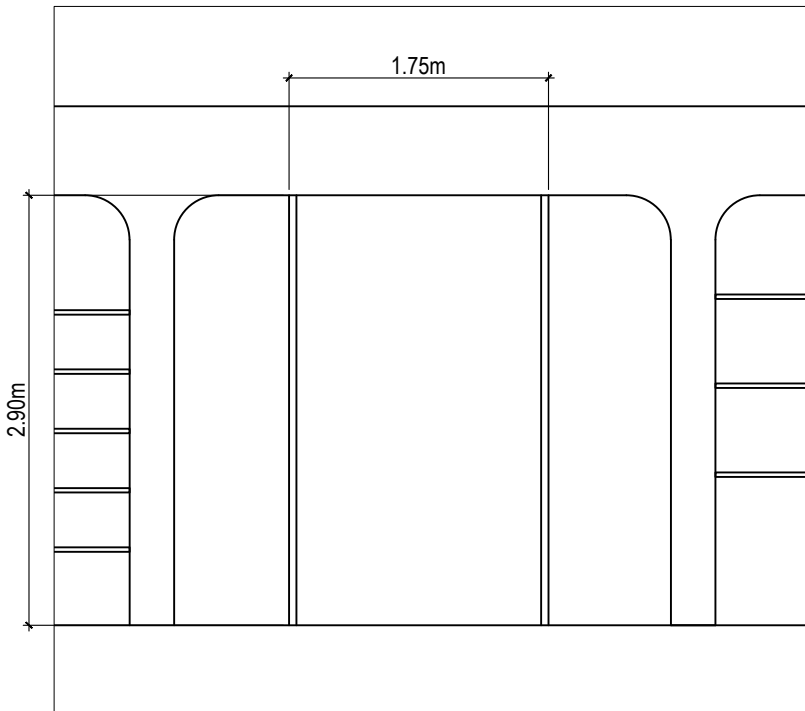

ELEVATION

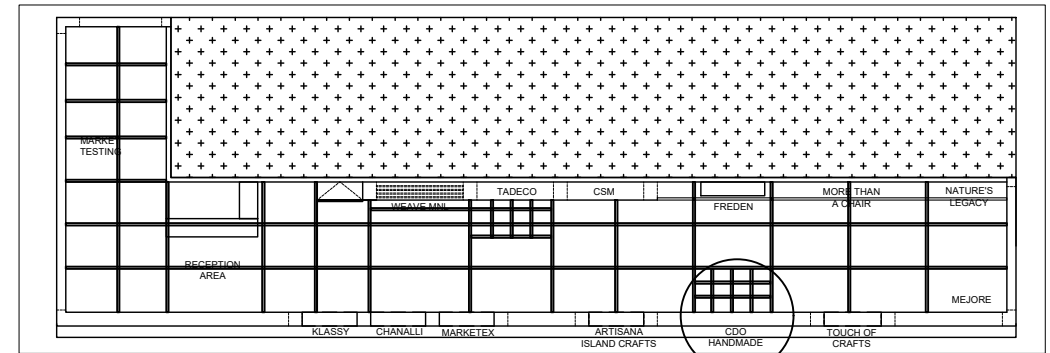

LOCATION MAP



PERSPECTIVE

STRUCTURE WITH WOOD SLAT COVERING IN APPROVED PAINT FINISH

HANGING PROVISION FOR HANGING ITEMS

ADDITIONAL METAL SUPPORT

SPACE FOR FURNITURE PIECES

 EXHIBITION DESIGN DIVISION	PROJECT: AMBIENTE 2023	SHEET CONTENTS:	
	TITLE: DESIGN PHILIPPINES - WORKING DRAWING	WORKING DRAWING	
DATE / TIME: DECEMBER 27, 2022	LOCATION: FRANKFURT, GERMANY	SHEET NO.: 13	REVISION: 1

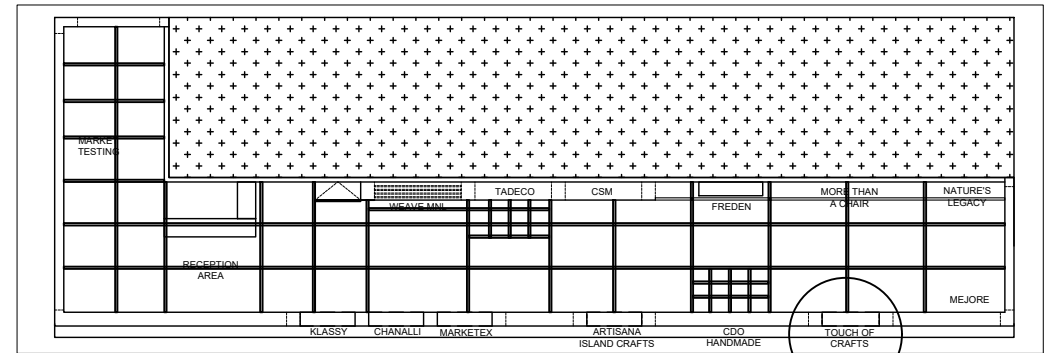
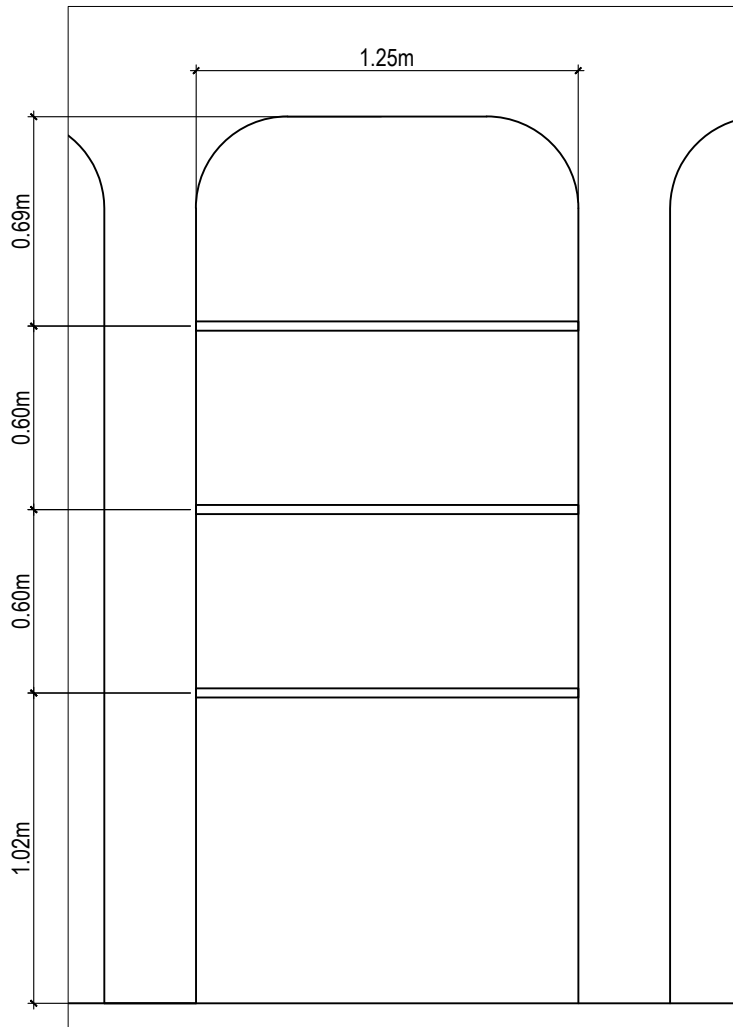
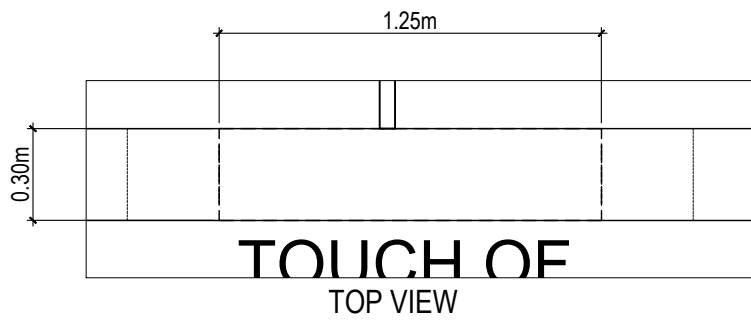

LOCATION MAP



PERSPECTIVE

STRUCTURE WITH WOOD SLAT COVERING
IN APPROVED PAINT FINISH

SHELVINGS ACCORDING TO PRODUCT HEIGHT

<p>EXHIBITION DESIGN DIVISION</p>	<p>PROJECT: AMBIENTE 2023</p>	<p>SHEET CONTENTS:</p>	
	<p>TITLE: DESIGN PHILIPPINES - WORKING DRAWING</p>	<p>WORKING DRAWING</p>	
<p>DATE / TIME: DECEMBER 27, 2022</p>	<p>LOCATION: FRANKFURT, GERMANY</p>	<p>SHEET NO.: 14</p>	<p>REVISION: 1</p>

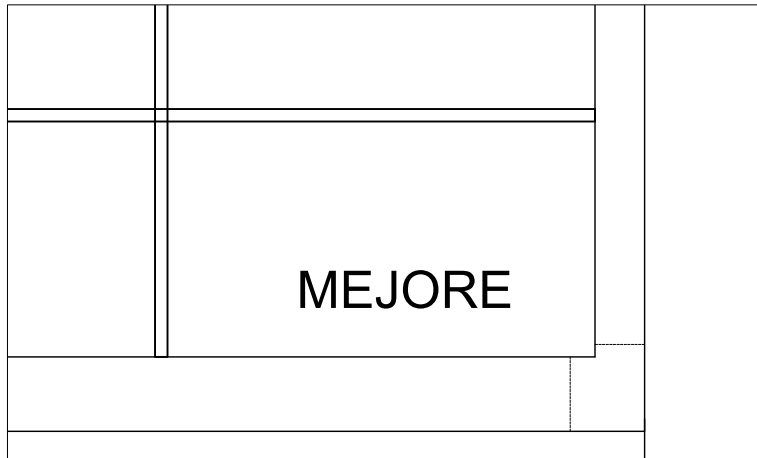

TOP VIEW

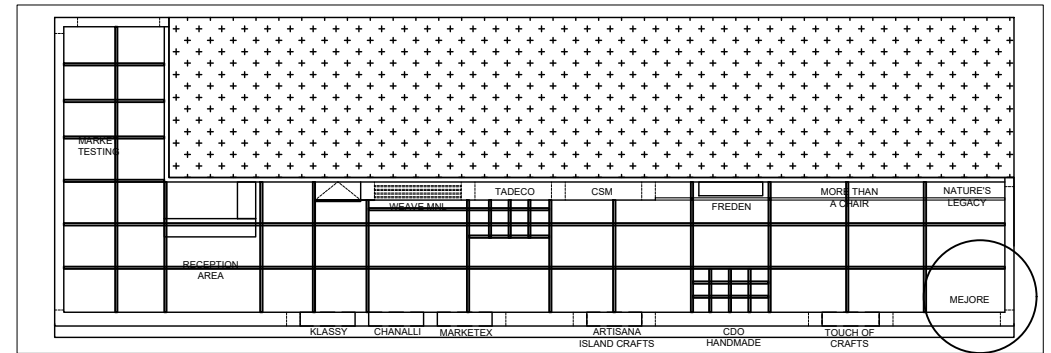

LOCATION MAP

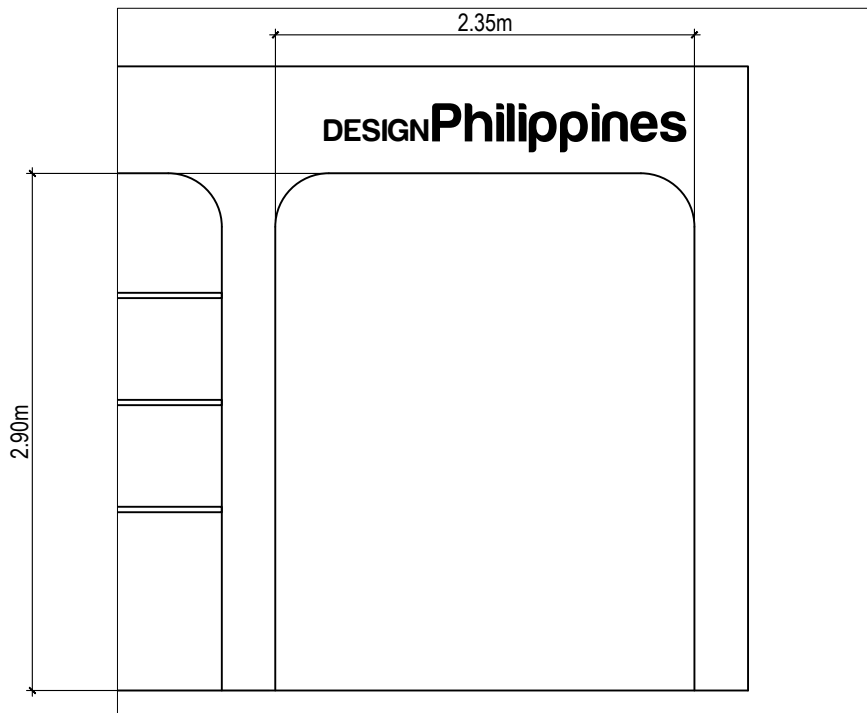

ELEVATION

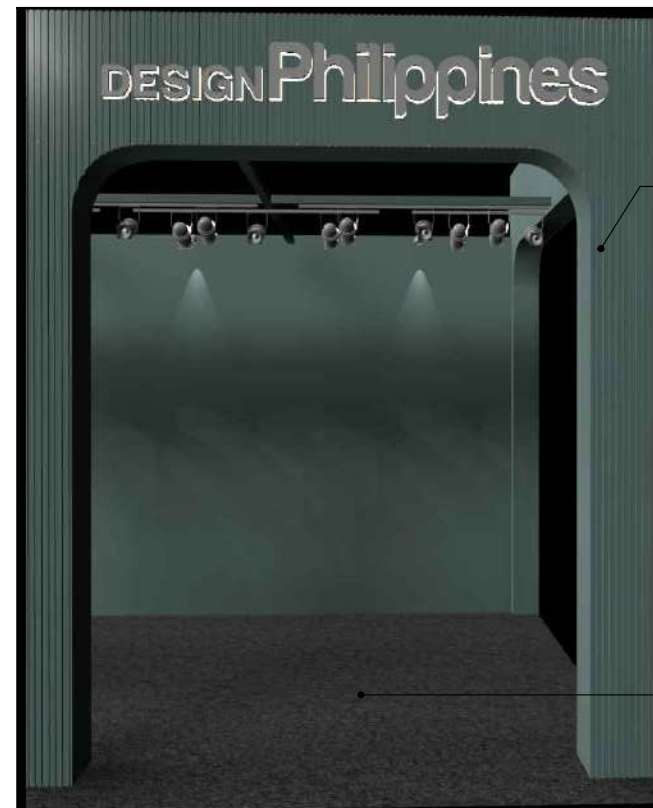

PERSPECTIVE

STRUCTURE WITH WOOD SLAT COVERING IN APPROVED PAINT FINISH

SPACE FOR FURNITURE PIECES

 EXHIBITION DESIGN DIVISION	PROJECT: AMBIENTE 2023	SHEET CONTENTS:	
	TITLE: DESIGN PHILIPPINES - WORKING DRAWING	WORKING DRAWING	
DATE / TIME: DECEMBER 27, 2022	LOCATION: FRANKFURT, GERMANY	SHEET NO.: 15	REVISION: 1

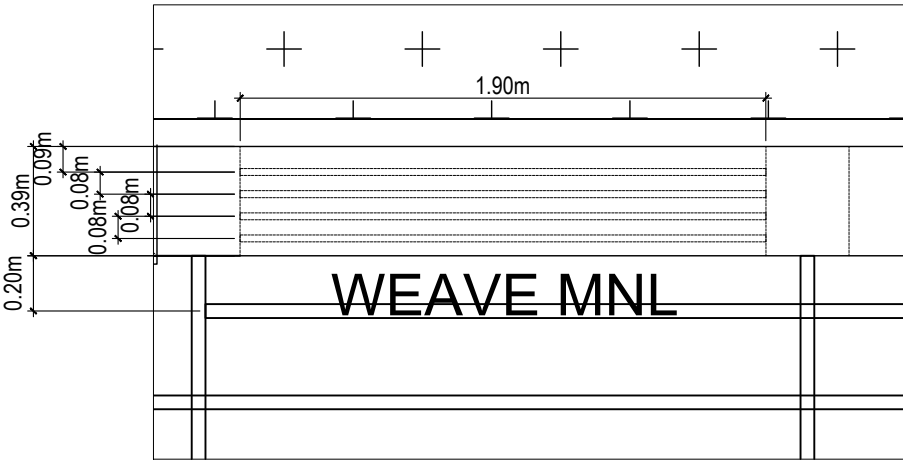

TOP VIEW

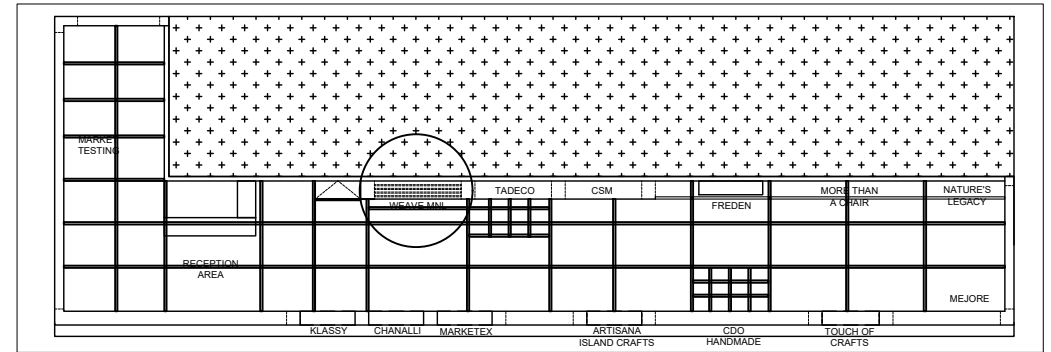

LOCATION MAP

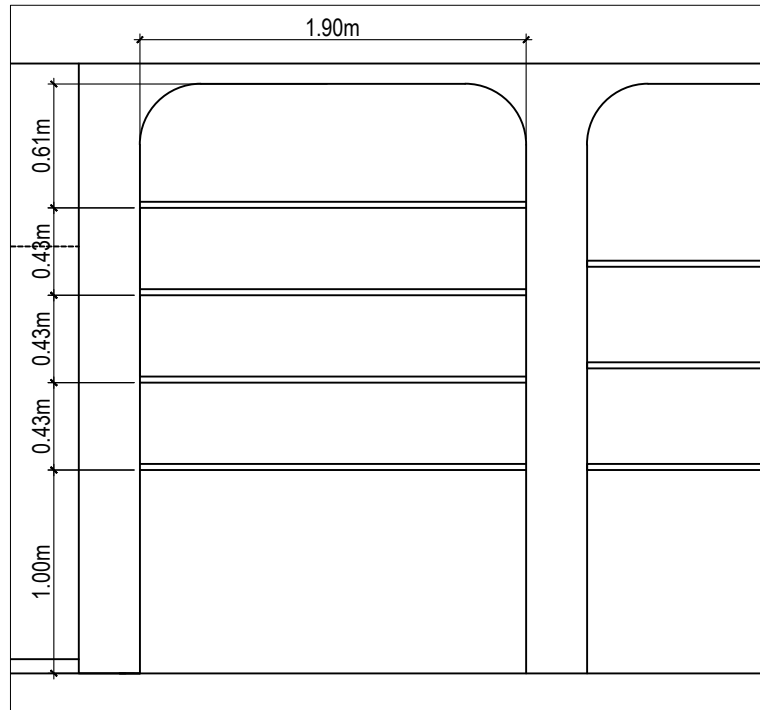

ELEVATION

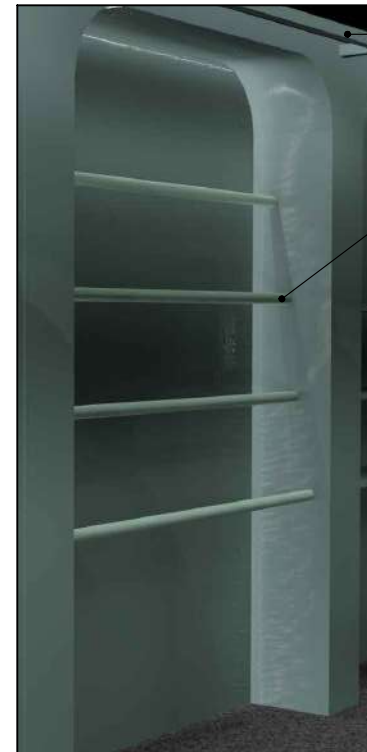

PERSPECTIVE

ADDITIONAL HANGING PROVISION

METAL ROD FOR HANGING OF ABACA MATS - IN APPROVED PAINT FINISH

*ONE ABACA CARPET WEIGHS 10-15 KG (EST.)

 EXHIBITION DESIGN DIVISION	PROJECT: AMBIENTE 2023	SHEET CONTENTS:	
	TITLE: DESIGN PHILIPPINES - WORKING DRAWING	WORKING DRAWING	
DATE / TIME: DECEMBER 27, 2022	LOCATION: FRANKFURT, GERMANY	SHEET NO.: 16	REVISION: 1

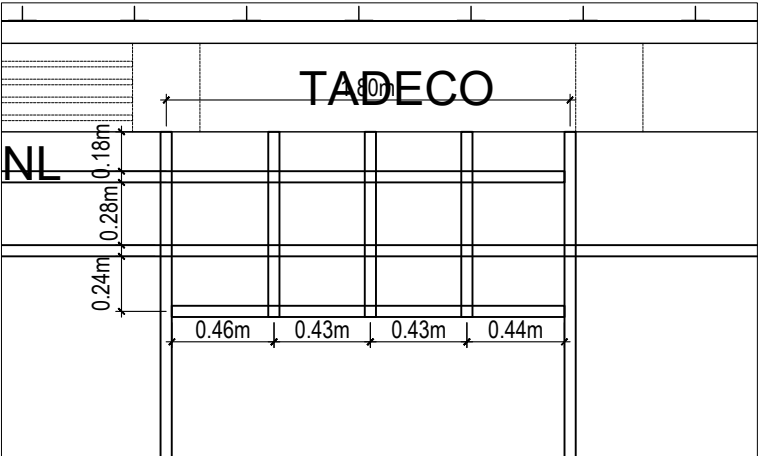

TOP VIEW

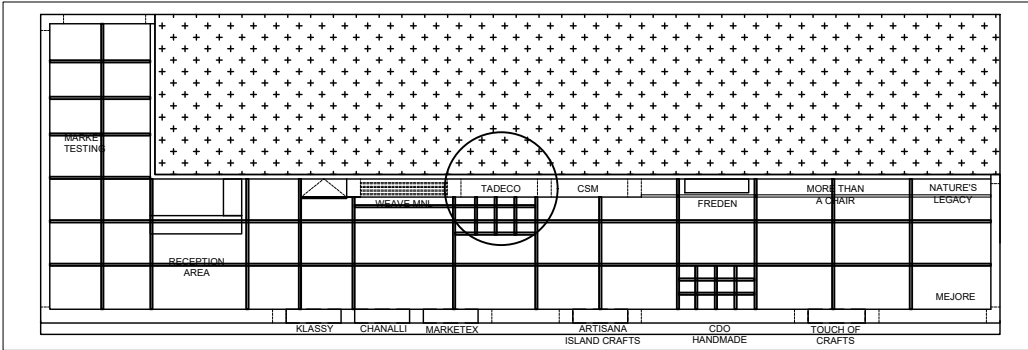

LOCATION MAP

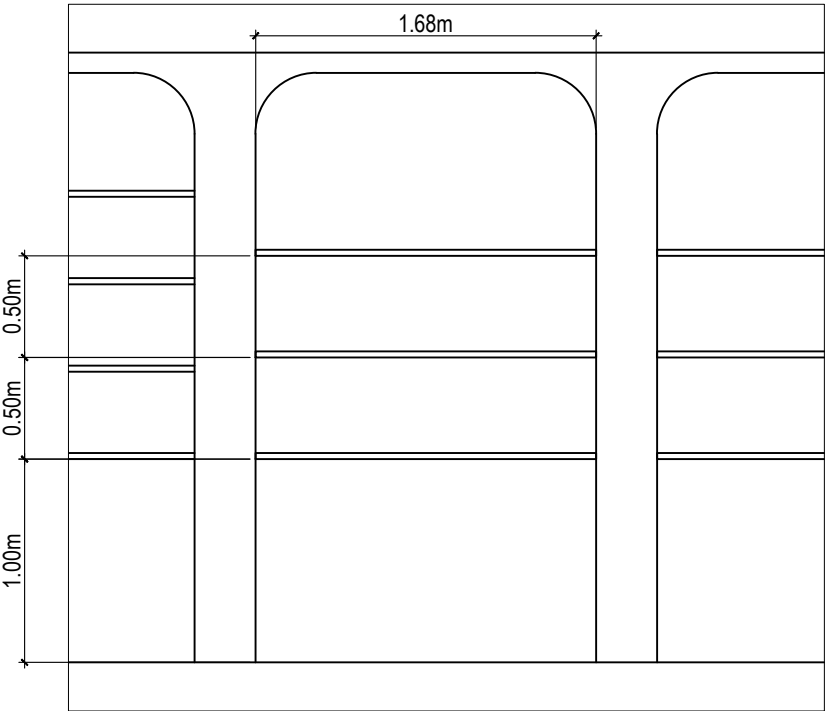

ELEVATION

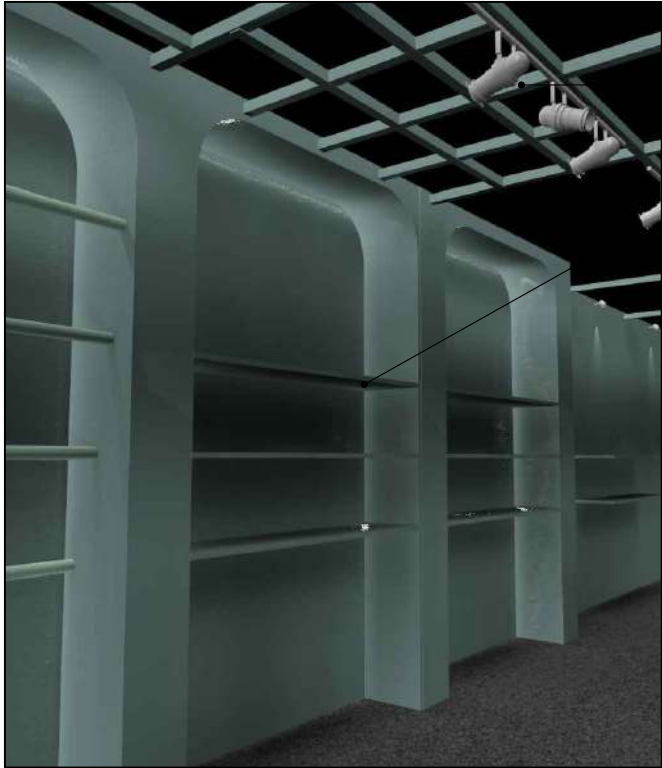

PERSPECTIVE

ADDITIONAL HANGING PROVISION

SHELVINGS ACCORDING TO
PRODUCT HEIGHT

 EXHIBITION DESIGN DIVISION	PROJECT: AMBIENTE 2023	SHEET CONTENTS:	
	TITLE: DESIGN PHILIPPINES - WORKING DRAWING	WORKING DRAWING	
DATE / TIME: DECEMBER 27, 2022	LOCATION: FRANKFURT, GERMANY	SHEET NO.: 17	REVISION: 1

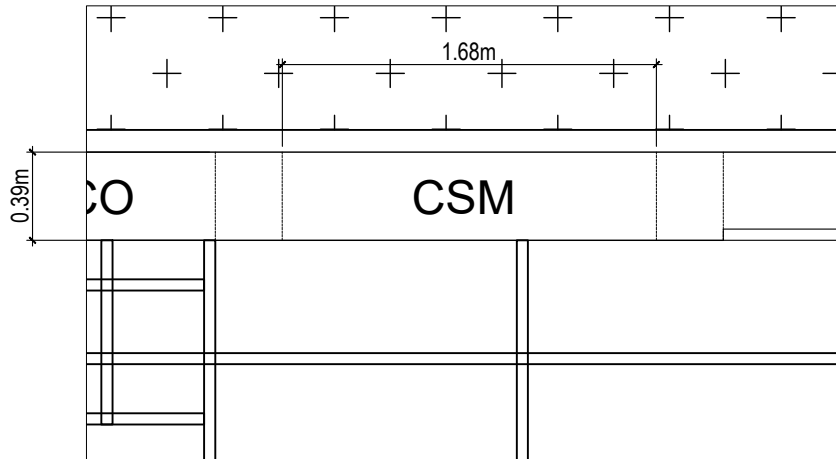

TOP VIEW

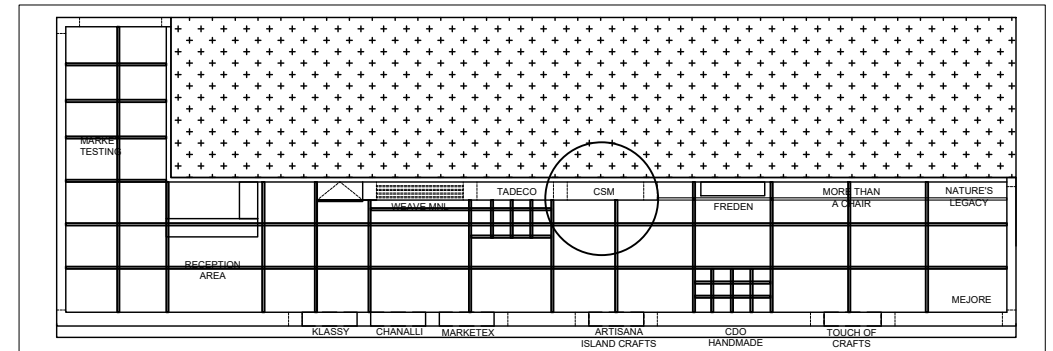

LOCATION MAP

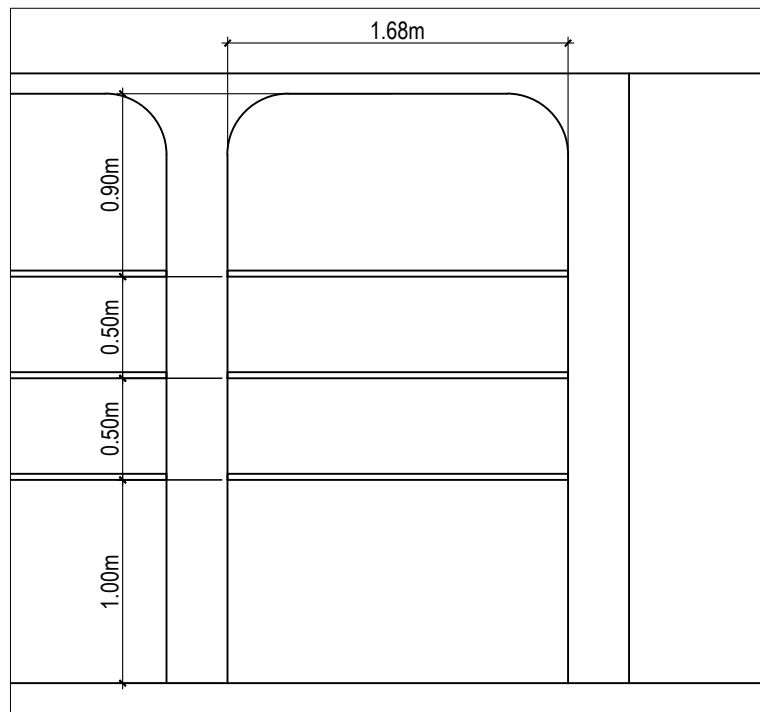

ELEVATION



PERSPECTIVE

SHELVINGS ACCORDING TO
PRODUCT HEIGHT

 EXHIBITION DESIGN DIVISION	PROJECT: AMBIENTE 2023	SHEET CONTENTS:	
	TITLE: DESIGN PHILIPPINES - WORKING DRAWING	WORKING DRAWING	
DATE / TIME: DECEMBER 27, 2022	LOCATION: FRANKFURT, GERMANY	SHEET NO.: 18	REVISION: 1

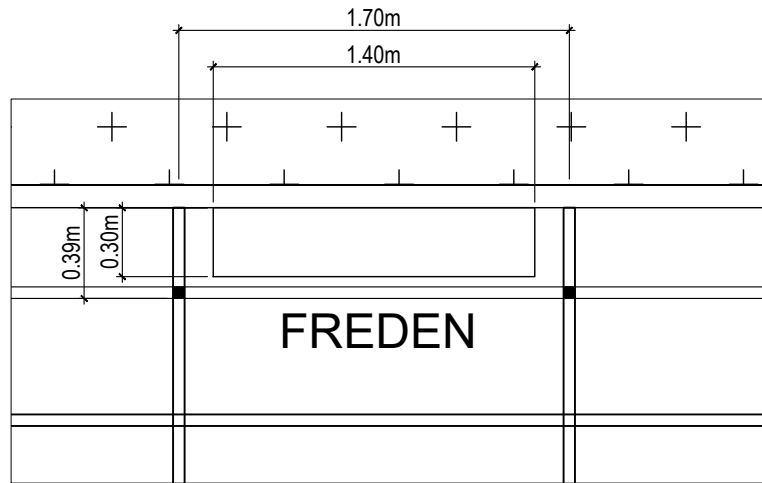

TOP VIEW

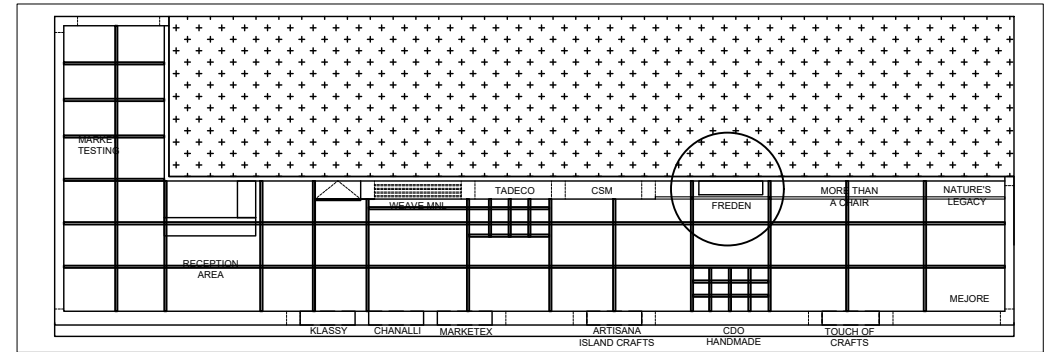

LOCATION MAP

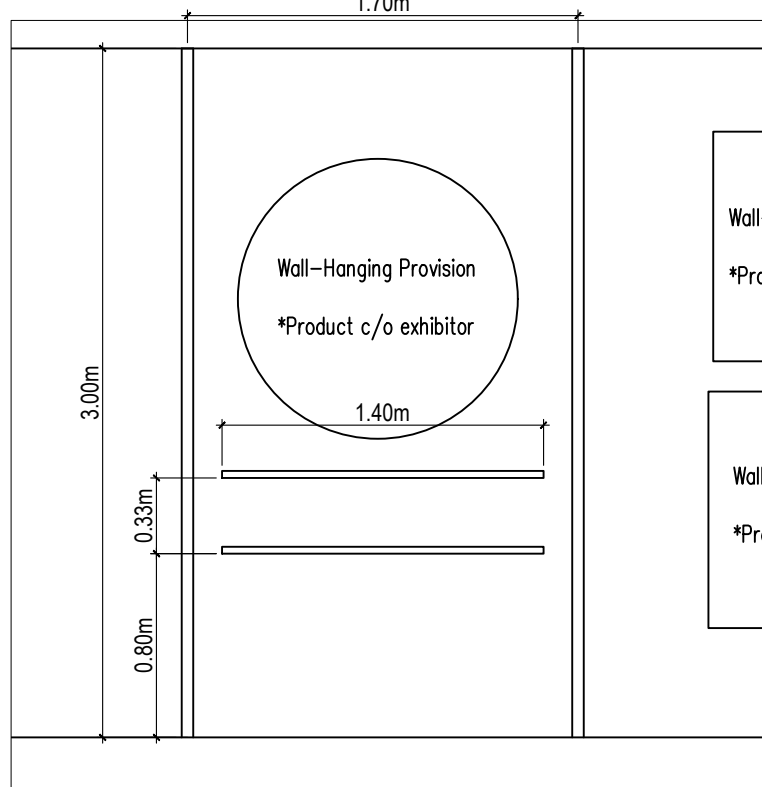

ELEVATION



PERSPECTIVE

<p>EXHIBITION DESIGN DIVISION</p>	PROJECT: AMBIENTE 2023	SHEET CONTENTS:	
	TITLE: DESIGN PHILIPPINES - WORKING DRAWING	WORKING DRAWING	
DATE / TIME: DECEMBER 27, 2022	LOCATION: FRANKFURT, GERMANY	SHEET NO.: 19	REVISION: 1

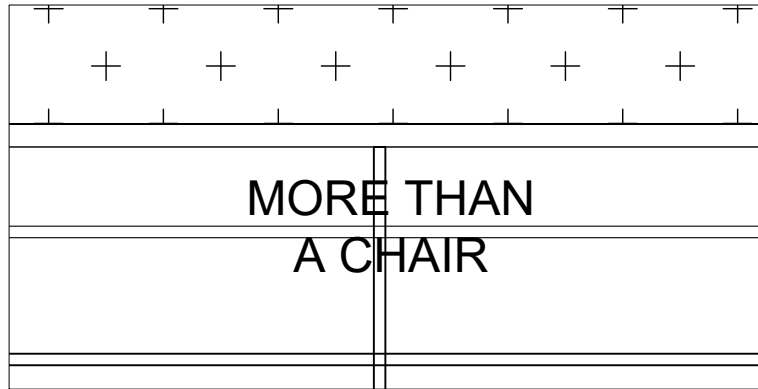

TOP VIEW

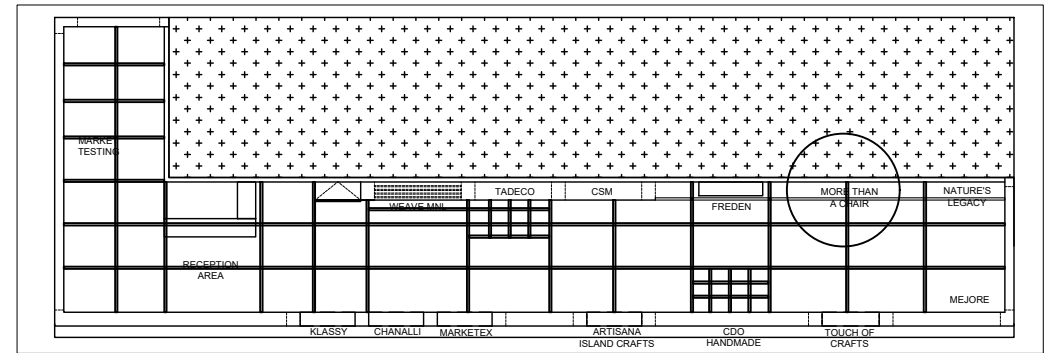

LOCATION MAP

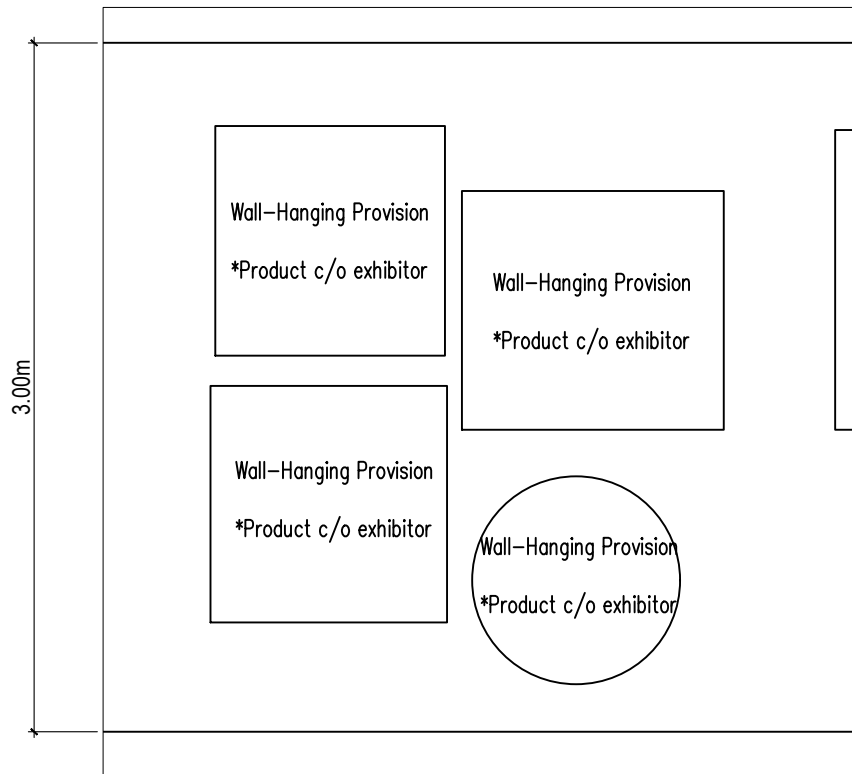

ELEVATION



PERSPECTIVE

 EXHIBITION DESIGN DIVISION	PROJECT: AMBIENTE 2023	SHEET CONTENTS:	
	TITLE: DESIGN PHILIPPINES - WORKING DRAWING	WORKING DRAWING	
DATE / TIME: DECEMBER 27, 2022	LOCATION: FRANKFURT, GERMANY	SHEET NO.: 20	REVISION: 1

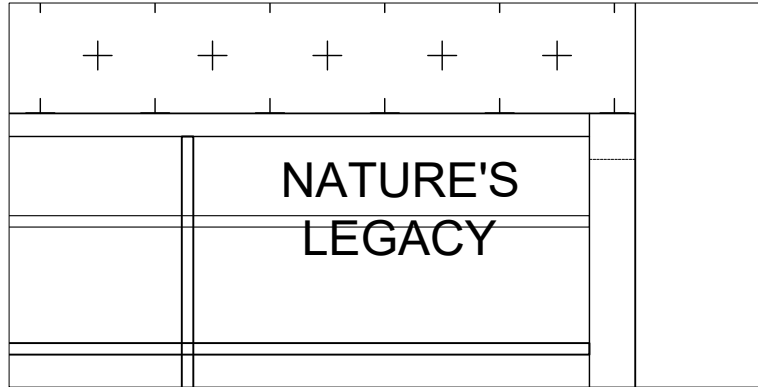

TOP VIEW

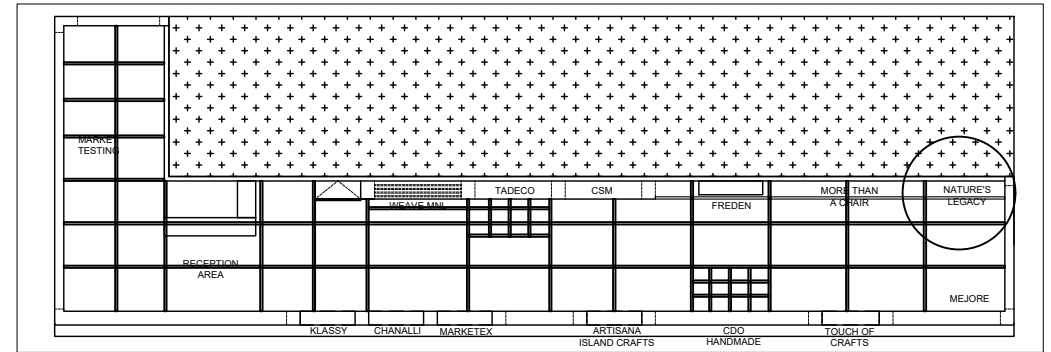

LOCATION MAP

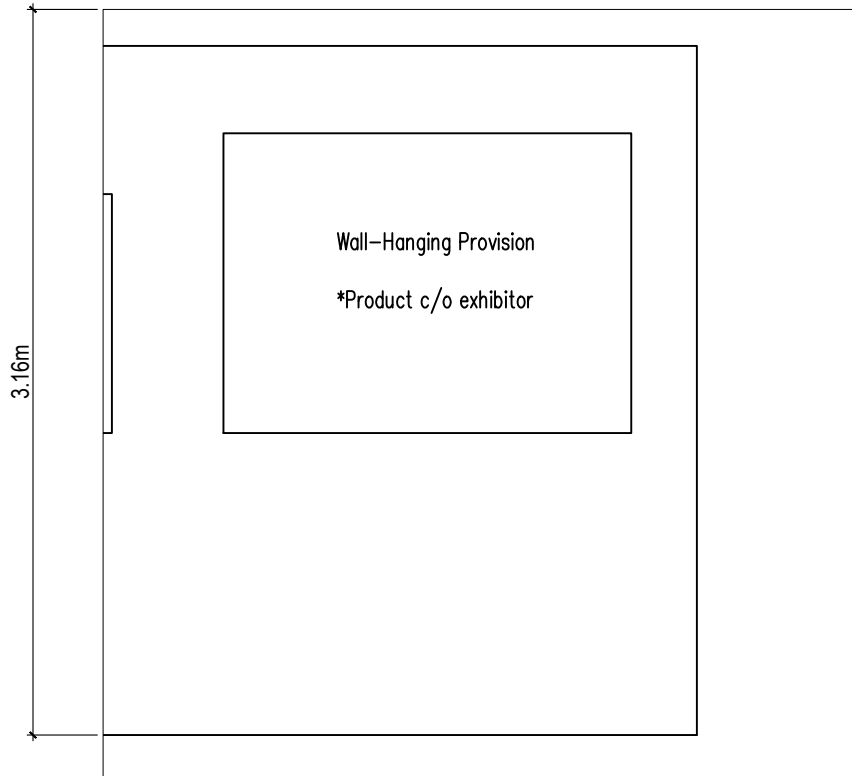

ELEVATION



PERSPECTIVE

 EXHIBITION DESIGN DIVISION	PROJECT: AMBIENTE 2023	SHEET CONTENTS:	
	TITLE: DESIGN PHILIPPINES - WORKING DRAWING	WORKING DRAWING	
DATE / TIME: DECEMBER 27, 2022	LOCATION: FRANKFURT, GERMANY	SHEET NO.: 21	REVISION: 1

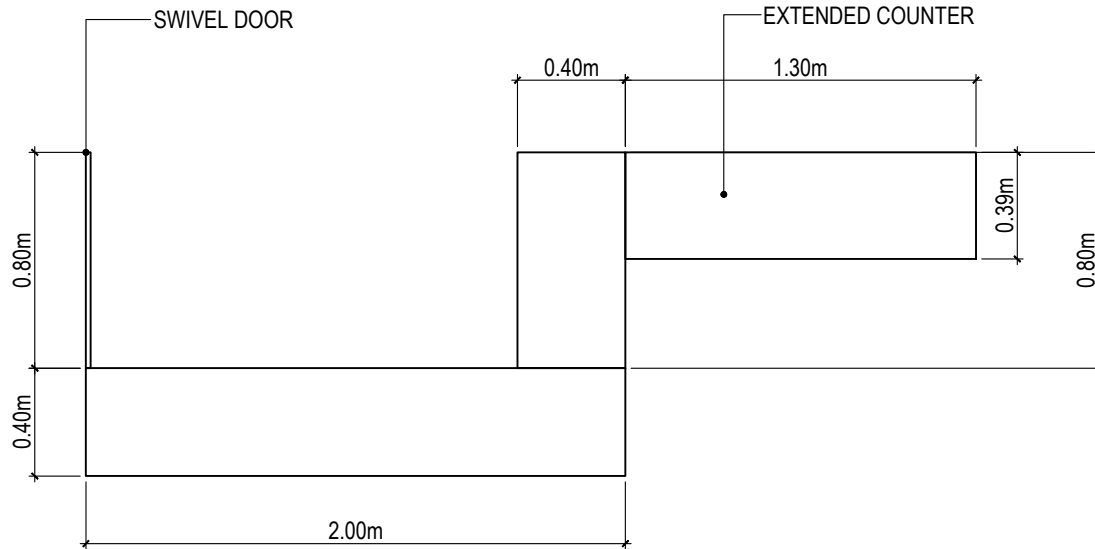

TOP VIEW

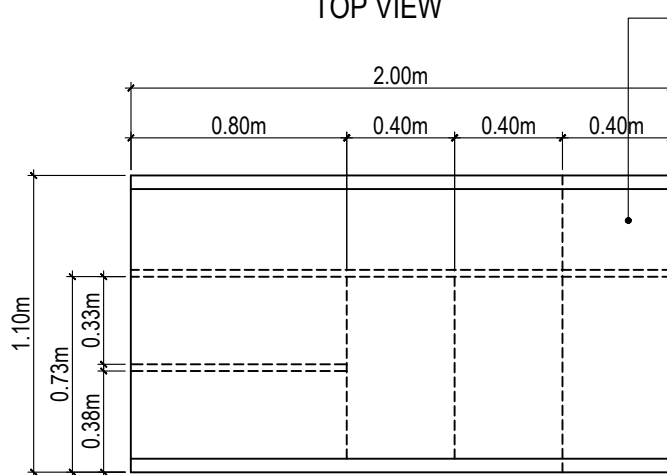

FRONT ELEVATION

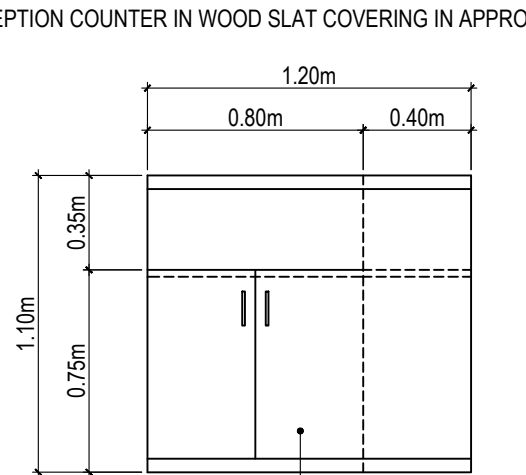

SIDE ELEVATION

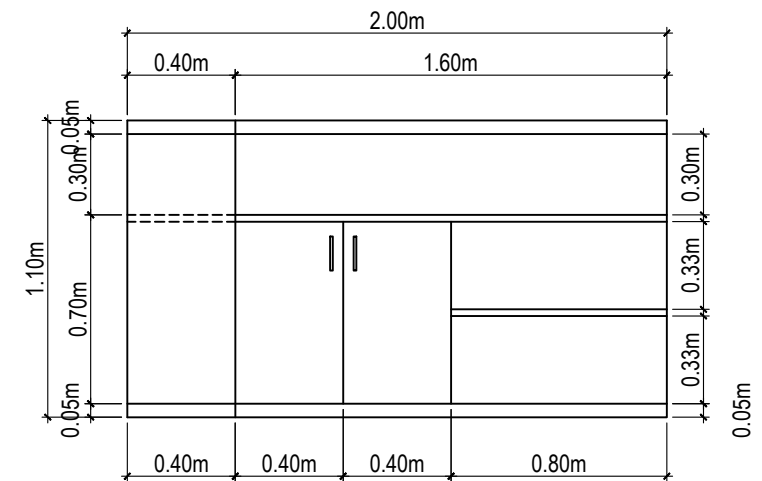

REAR VIEW



PROJECT:	AMBIENTE 2023	SHEET CONTENTS:	
	EXHIBITION DESIGN DIVISION	WORKING DRAWING	
TITLE:	DESIGN PHILIPPINES - WORKING DRAWING	SHEET NO.:	REVISION:
DATE / TIME:	LOCATION:		
DECEMBER 27, 2022	FRANKFURT, GERMANY	22	1

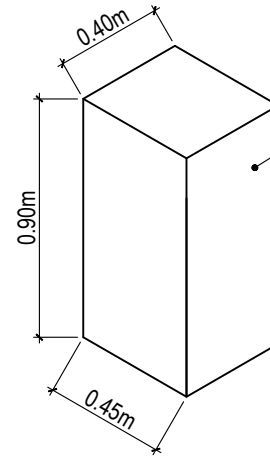
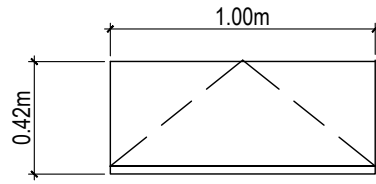

WOODEN PEDESTAL IN APPROVED PAINT FINISH
PEDESTAL A
3 UNITS

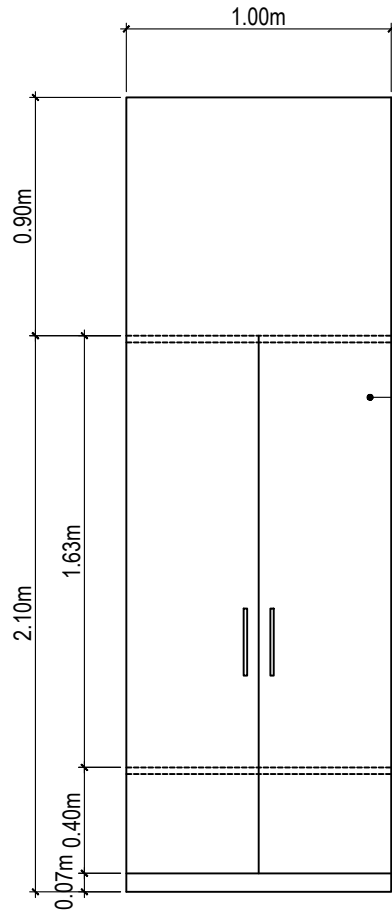

LOCKABLE CABINET
IN APPROVED
PAINT FINISH

2 - CLOAK CABINET
1 UNIT

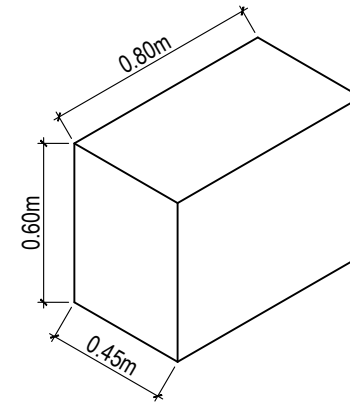

PEDESTAL B
3 UNITS

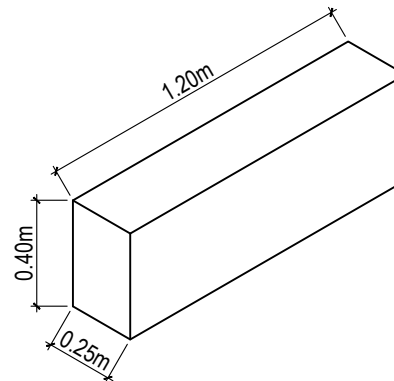

PEDESTAL C
5 UNITS

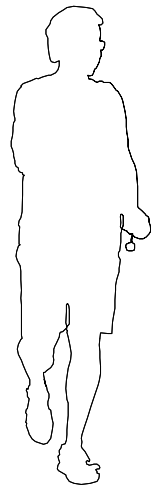

EXHIBITION DESIGN DIVISION	PROJECT:	AMBIENTE 2023	SHEET CONTENTS:	
	TITLE:	DESIGN PHILIPPINES - WORKING DRAWING	WORKING DRAWING	
DATE / TIME: DECEMBER 27, 2022	LOCATION:	FRANKFURT, GERMANY	SHEET NO.: 23	REVISION: 1

FLOOR

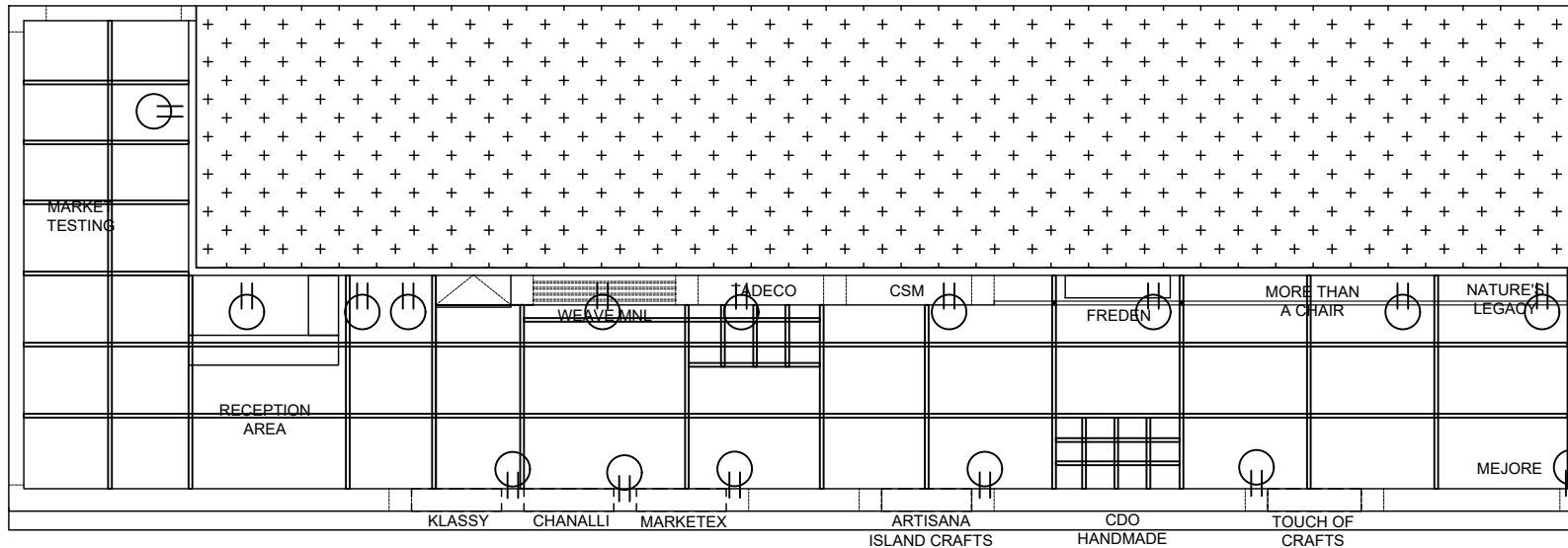

 16 units - 2 Gang Universal - Convenience Outlet

GRID

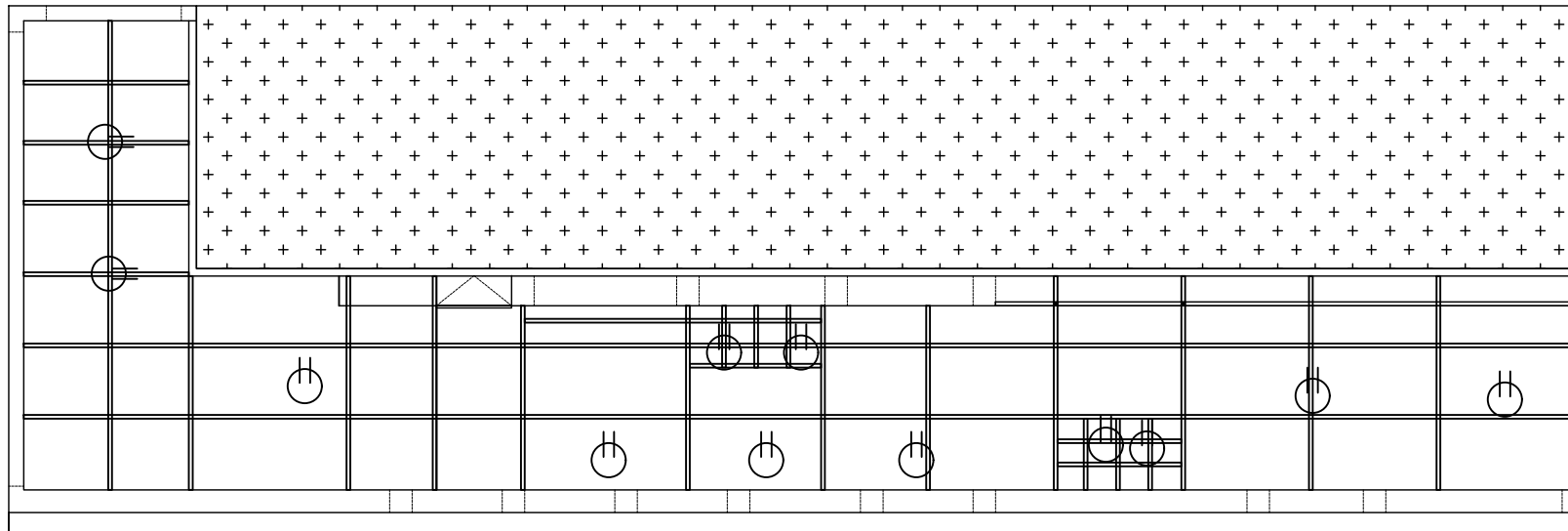

 12 units - 2 Gang Universal - Convenience Outlet

	PROJECT:	AMBIENTE 2023	SHEET CONTENTS:	
	TITLE:	DESIGN PHILIPPINES - WORKING DRAWING	WORKING DRAWING	
DATE / TIME:	LOCATION:	FRANKFURT, GERMANY	SHEET NO.:	REVISION:
DECEMBER 27, 2022			24	1

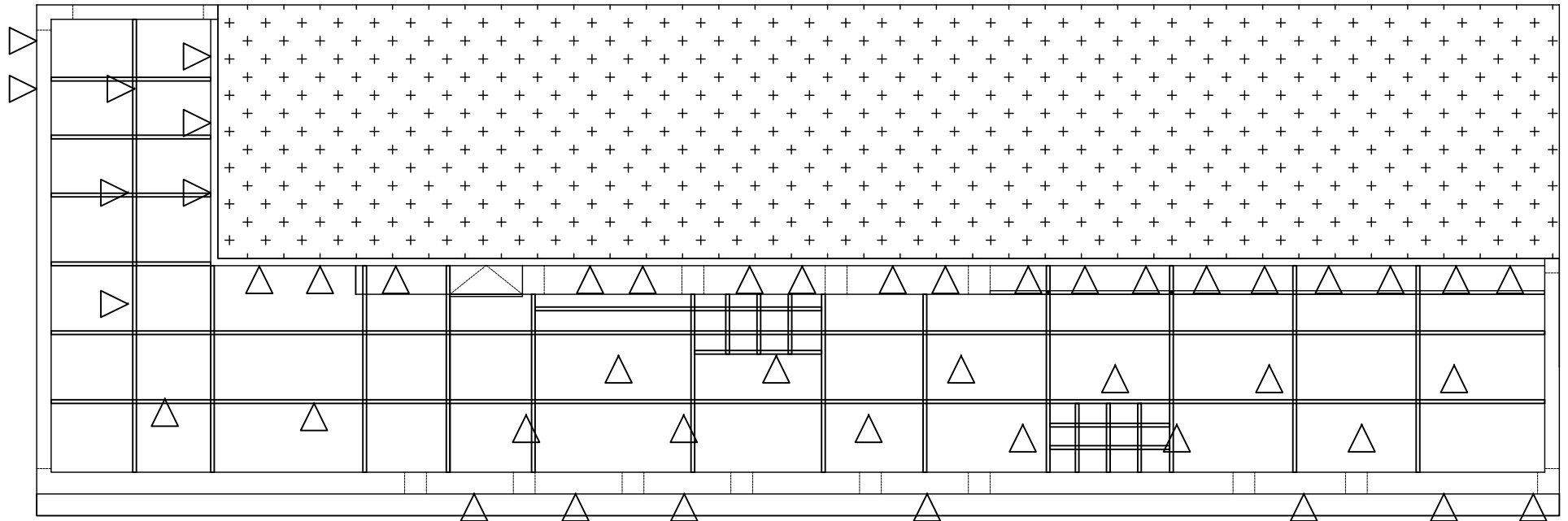

△ 47 units - 10-12 watts - Daylight Spotlight

 EXHIBITION DESIGN DIVISION	PROJECT: AMBIENTE 2023	SHEET CONTENTS: WORKING DRAWING	
	TITLE: DESIGN PHILIPPINES - WORKING DRAWING	SHEET NO.: 25	REVISION: 1
DATE / TIME: DECEMBER 27, 2022	LOCATION: FRANKFURT, GERMANY		